

Skiff Large Cafe Table

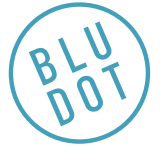

DESIGNED IN 2012

ASSEMBLY NOTES | REV 01

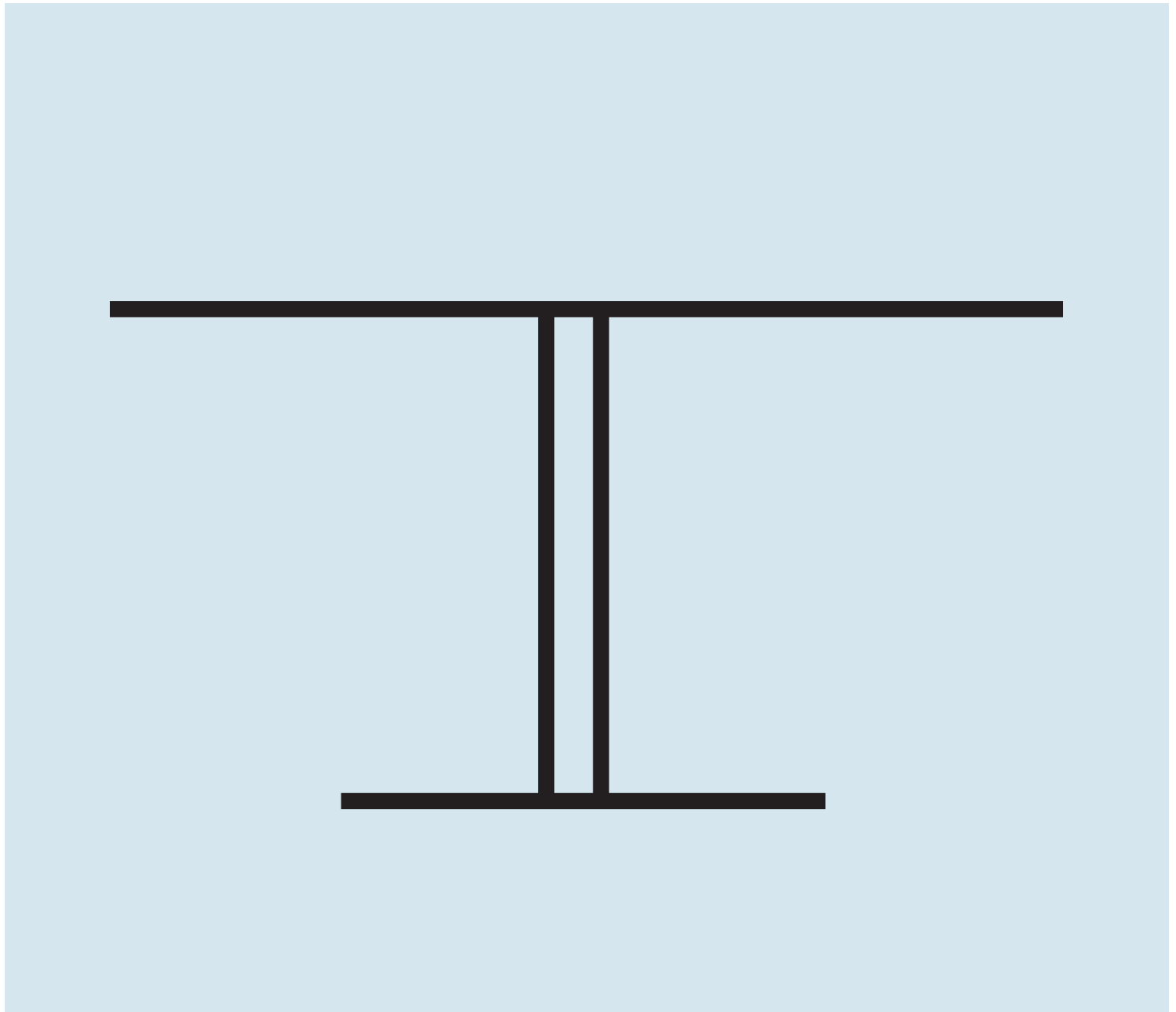

WHITE HEAT.

Crisp minimal white powder-coated aluminum and solid laminate top.
Clean lines designed to weather the elements.

NEED A HAND?

Contact us at service@bludot.com or
844.425.8368 for assistance.

Parts & Hardware

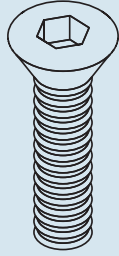

QTY 8

Pt. 1056



QTY 8

Pt. 1057

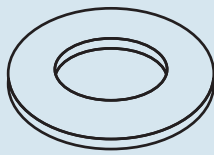

QTY 8

Pt. 3007

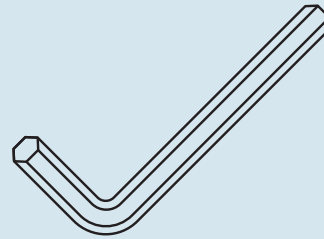

QTY 1

Pt. 9004

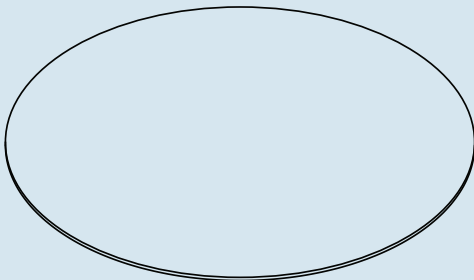

QTY 1

Top Panel

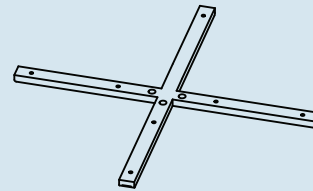

QTY 1

Metal Plate

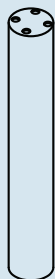

QTY 1

Support Column

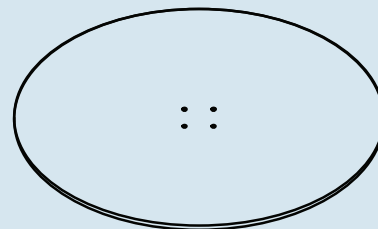

QTY 1

Base Plate

Step 01

ATTACH METAL PLATE.

Attach metal plate to support column as shown using the provided hardware.

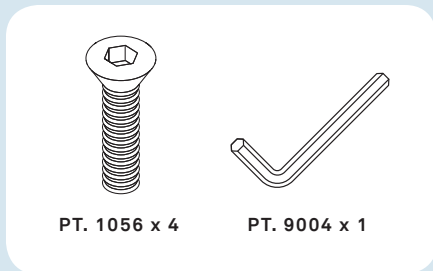
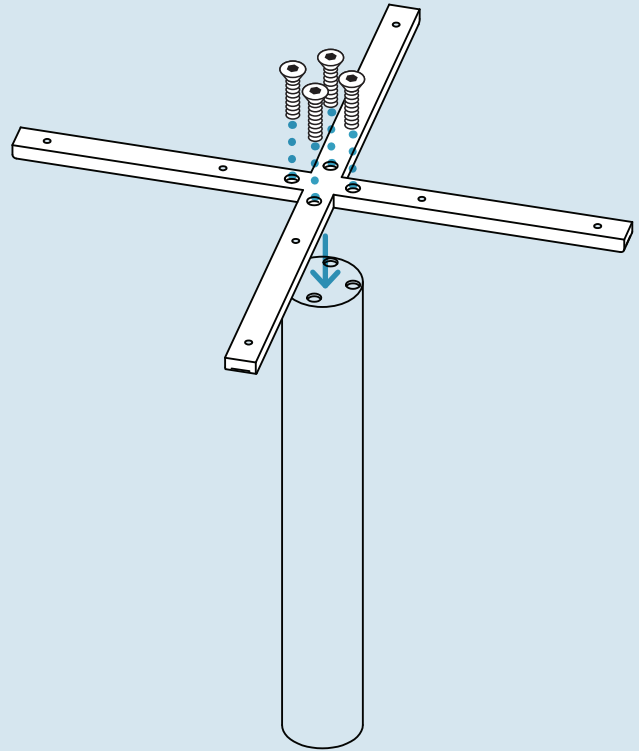

Step 02

ATTACH BASE PLATE.

Attach base plate to support column as shown using the provided hardware.

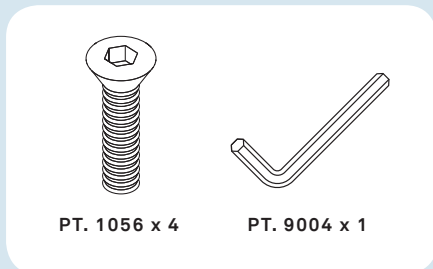
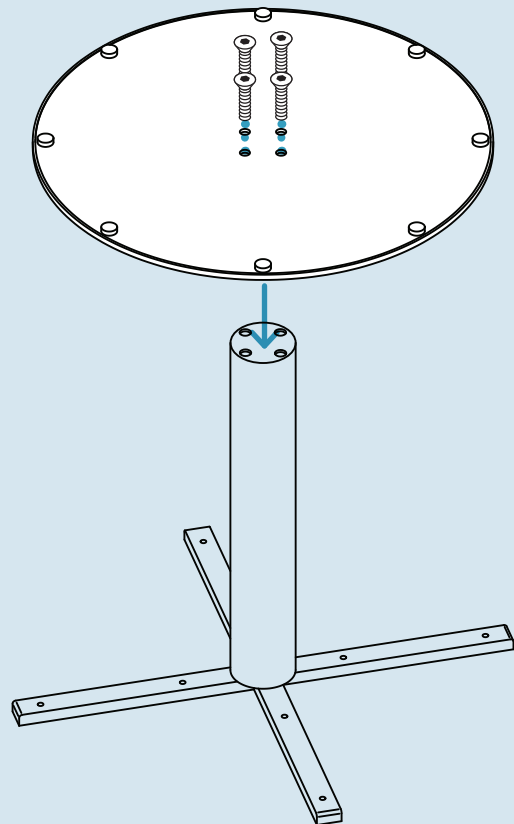

Step 03

ATTACH TOP PANEL.

Attach base assembly to table top as shown using the provided hardware.

NOTE: Place table top on carpet or similarly soft surface to protect from scratches during assembly.

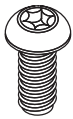
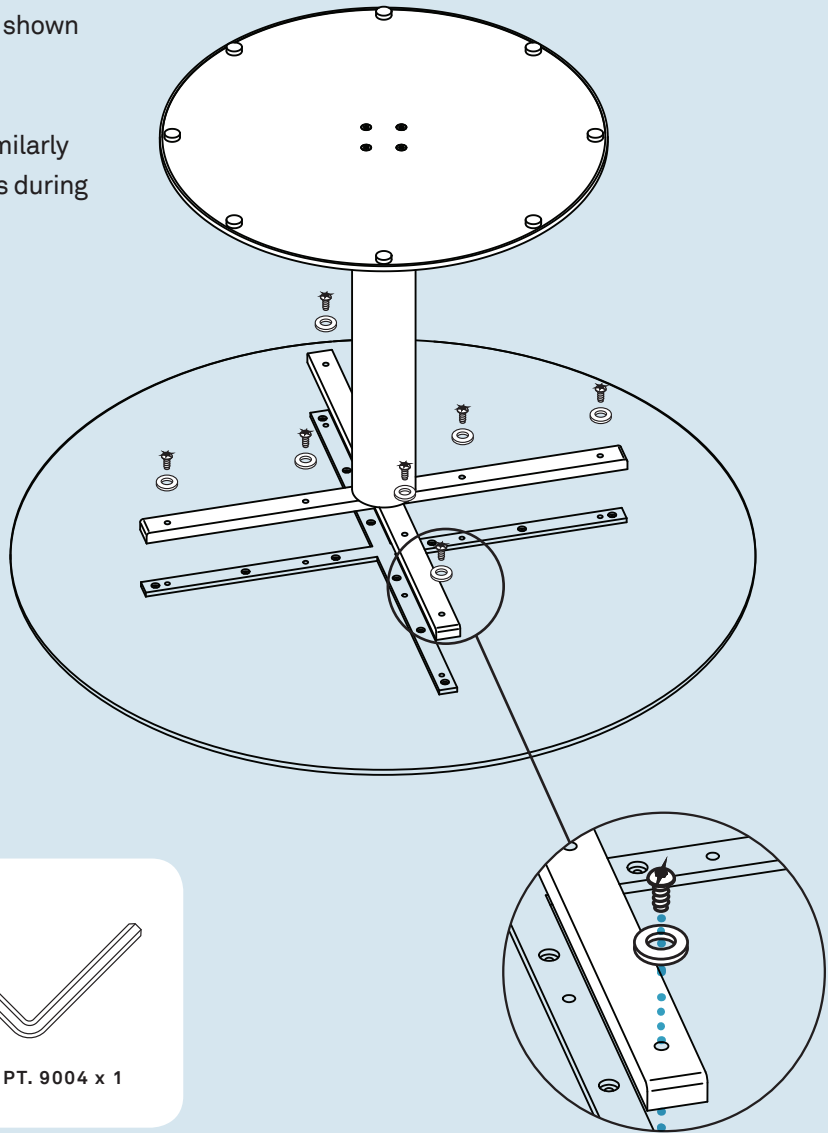

PT. 1057 x 8



PT. 3007 x 8

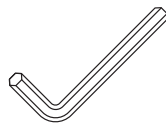

PT. 9004 x 1

Additional Information

CLEAN

Clean with a slightly damp, soft cloth. To remove dirt and fingerprints use warm water and a mild detergent, such as dish soap. Wipe dry with a soft cloth.

PROTECT

Cover or store inside during the winter months.

