

BLU
DOT

NOTE FLOOR LAMP

ASSEMBLY NOTES

BEST NOTE YOU'VE
SEEN ALL DAY!

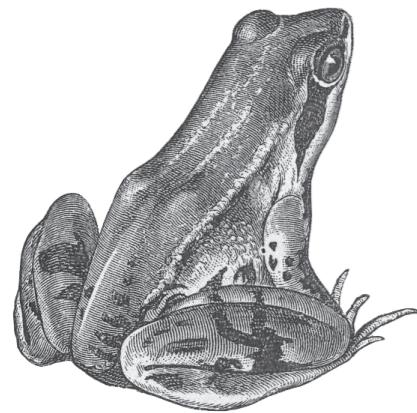
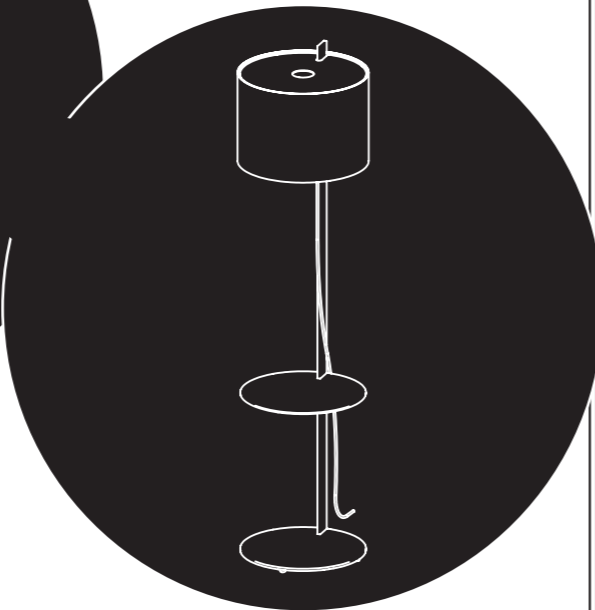

CARE

Disconnect the product
before cleaning. Clean
with a soft cloth.



Due to regulatory
requirements light bulbs
are provided. We
recommend using
A-19 LED bulbs.

HARDWARE

x1
9018

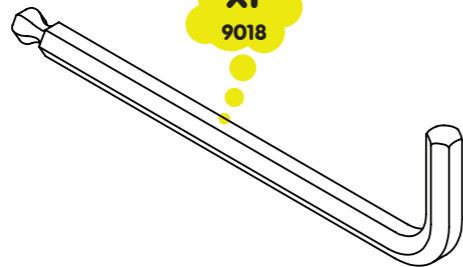

x6
1076

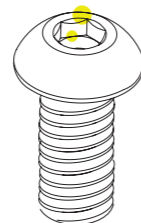

x6
8040



PARTS

x1

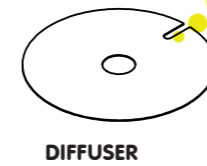

DIFFUSER

x1

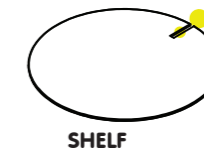

SHELF

x1

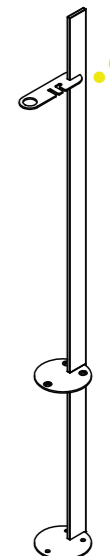

SUPPORT

x1



SOCKET

x1

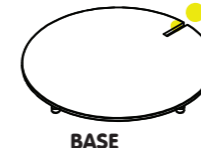

BASE

x1

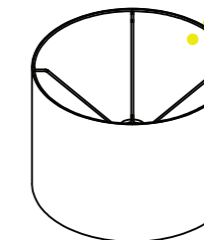

SHADE

1

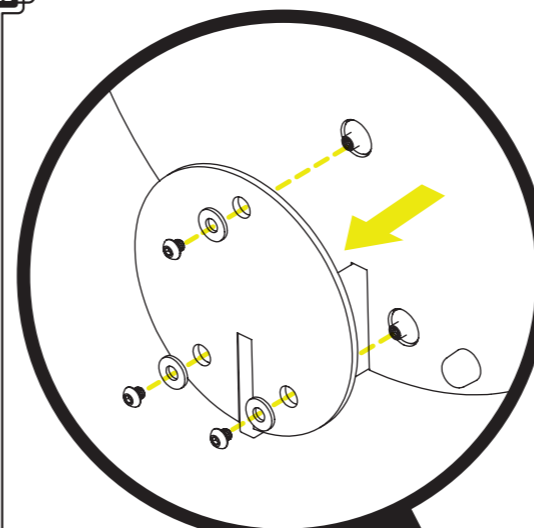

X6
1076

X6
8040

X1
9018

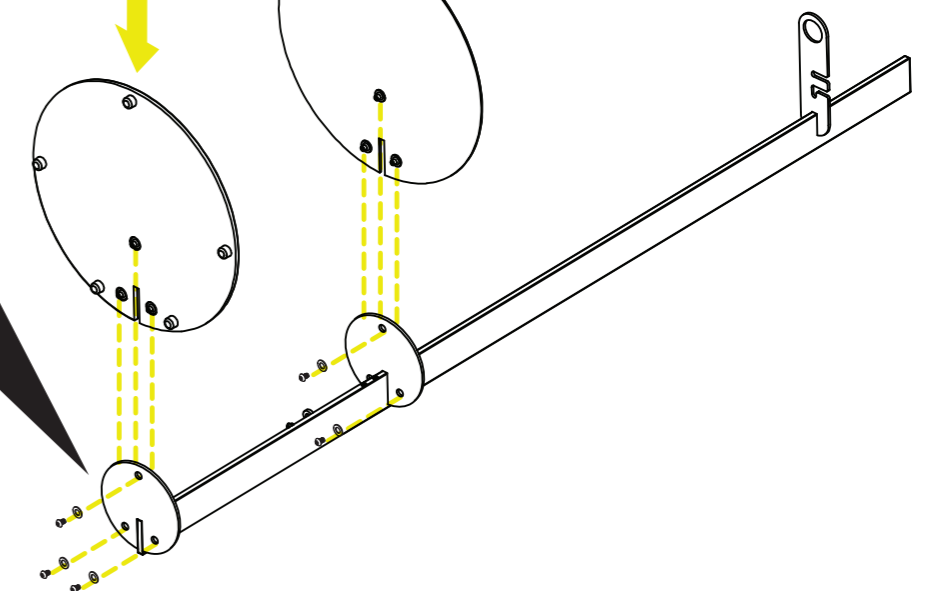

2

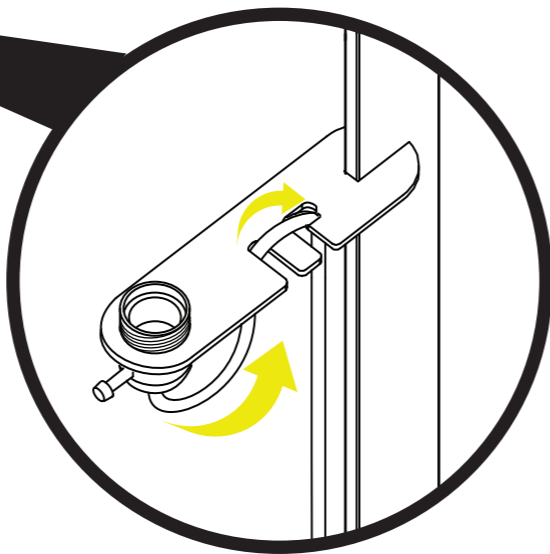
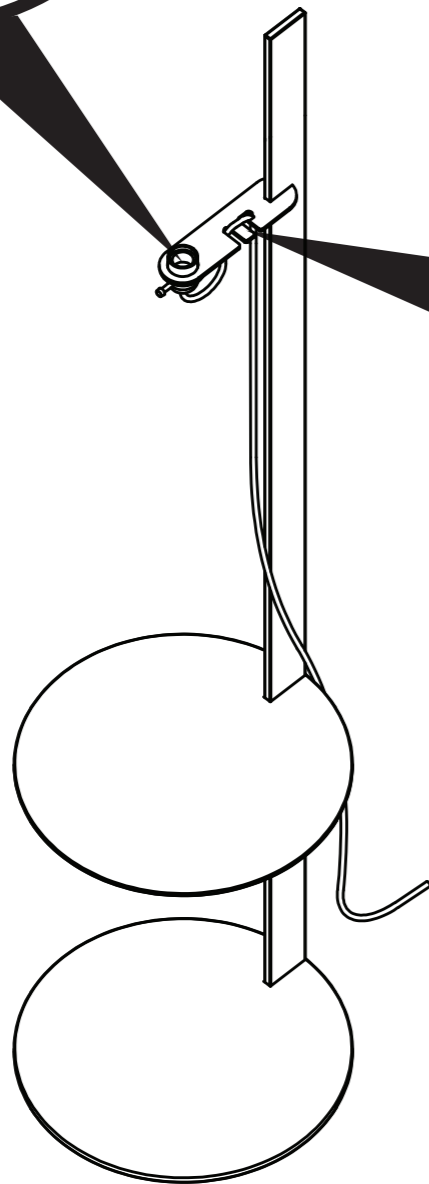
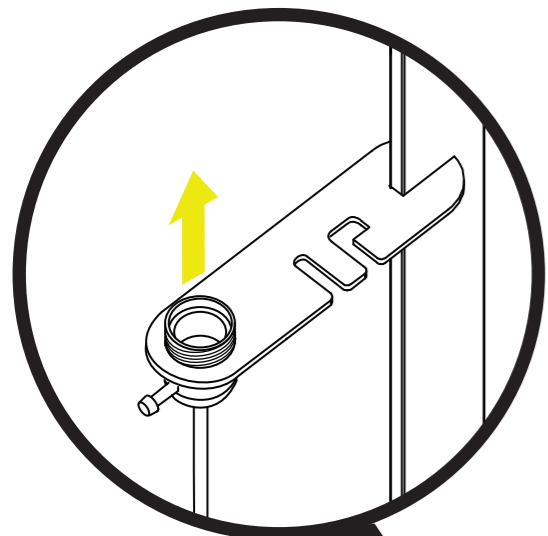

3

