

Mirror Mirror Collection

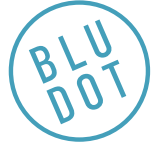

DESIGNED IN 2008

ASSEMBLY NOTES | REV 01

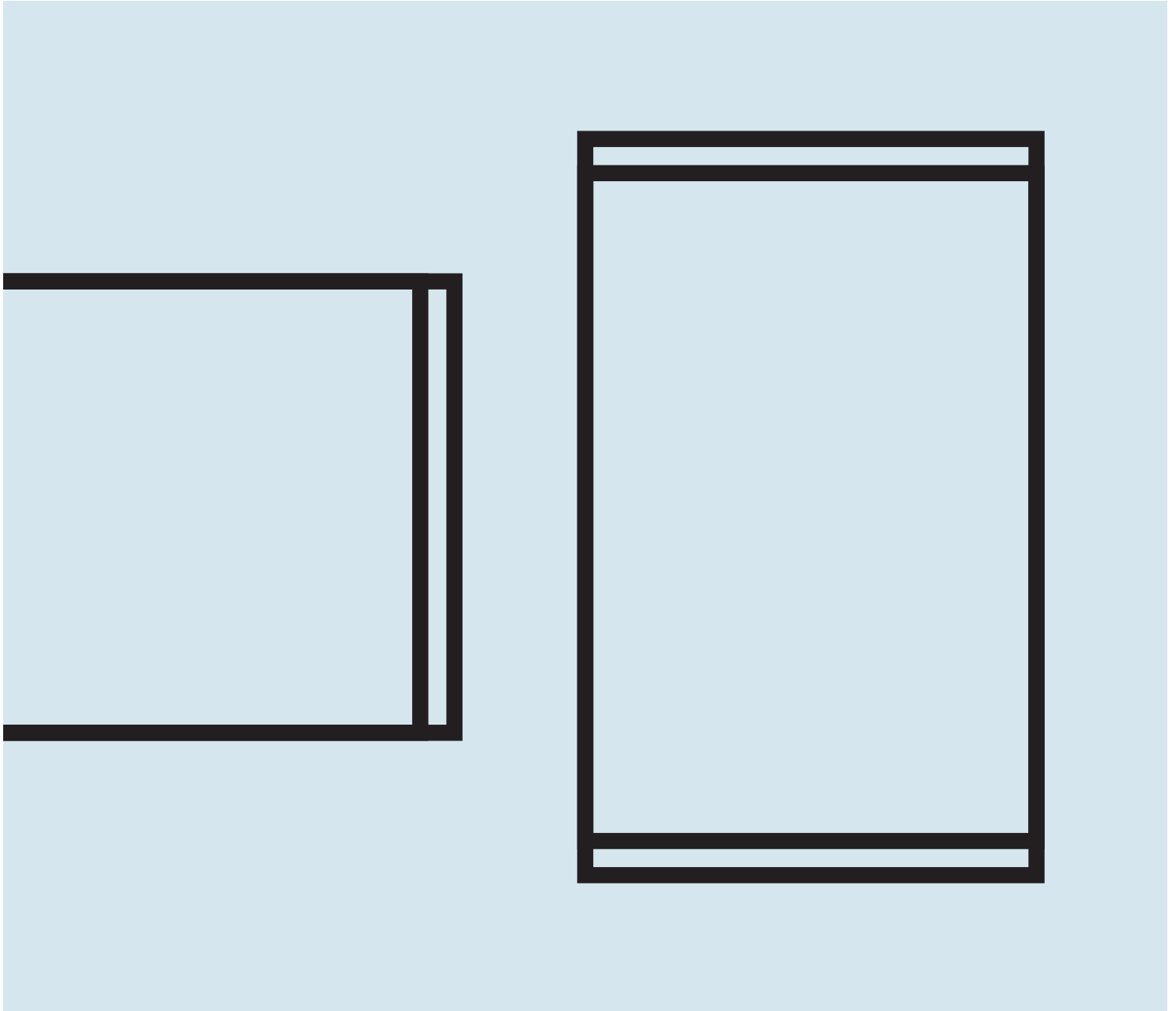

WICKED WITCHES NEVER HAD IT SO GOOD. POISON APPLES SOLD SEPARATELY.

Wicked witches never had it so good. Walnut pairs solidly with a black anodized aluminum framed mirror for a subtle, yet striking effect.

NEED A HAND?

Contact us at service@bludot.com or **844.425.8368** for assistance.

Parts & Hardware

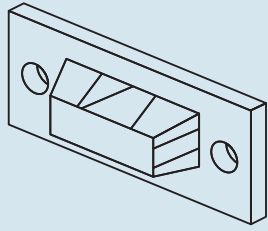

QTY 2

Pt. 8041

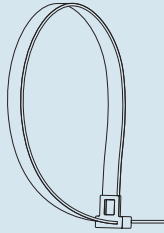

QTY 1

Pt. 8042

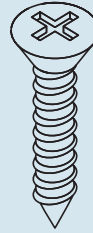

QTY 2

Pt. 1217

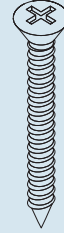

QTY 2

Pt. 1218

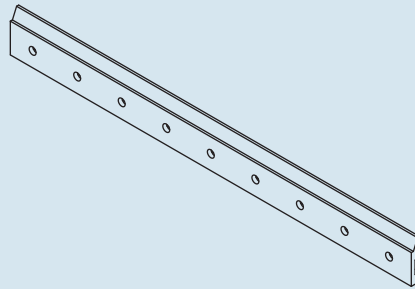

QTY 2

Wall Cleat

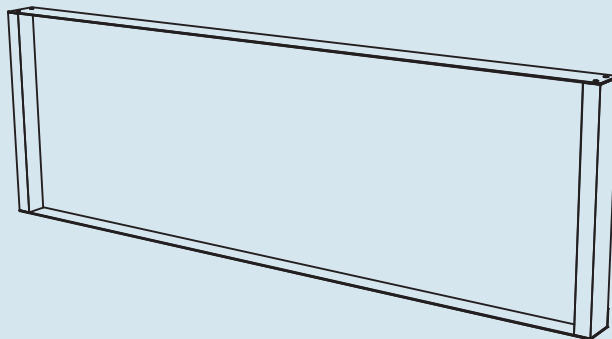

QTY 1

Mirror

Step 01

ATTACH WALL CLEATS.

Determine your desired mirror orientation. Attach x2 cleats for a horizontal mirror, x1 for a vertical mirror. Use the outermost holes first, then distribute the other screws based on the wall studs.

* Position the top of the wall cleat(s) 2" lower than your desired height of the mirror.

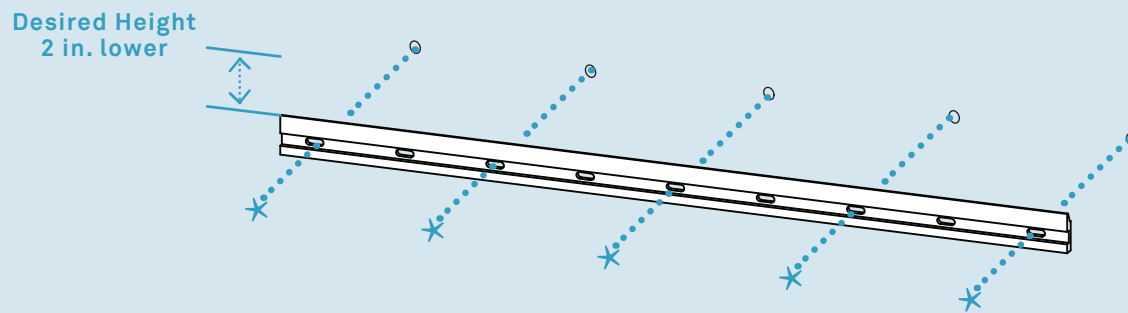

* It is recommended that you consult with a professional to determine the method and hardware required for installation.

Step 02

HANGING THE MIRROR VERTICALLY.

Place mirror against the wall above the wall cleat. Carefully slide mirror down along the wall until it engages with the wall cleat as shown.

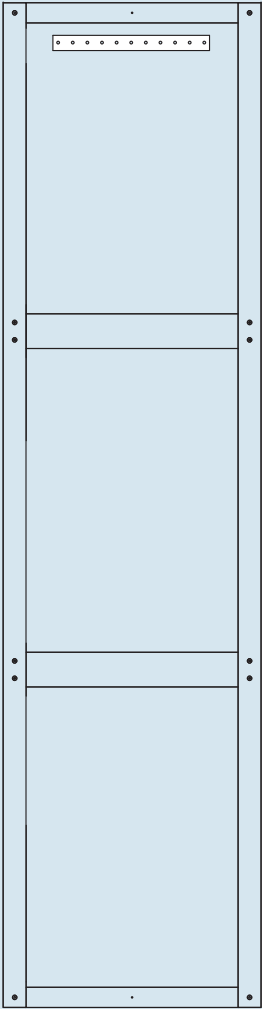

REAR VIEW

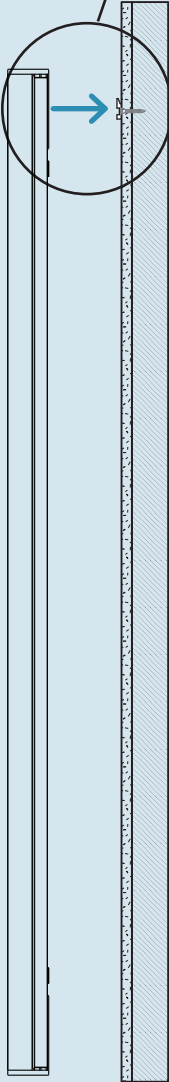

SIDE VIEW

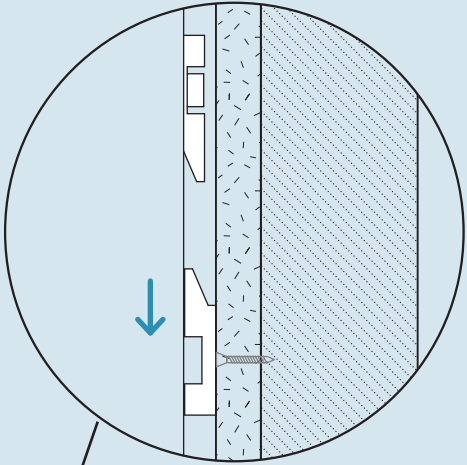

Step 03

HANGING THE MIRROR HORIZONTALLY.

Place mirror against the wall above the wall cleat. Carefully slide mirror down along the wall until it engages with the wall cleat as shown.

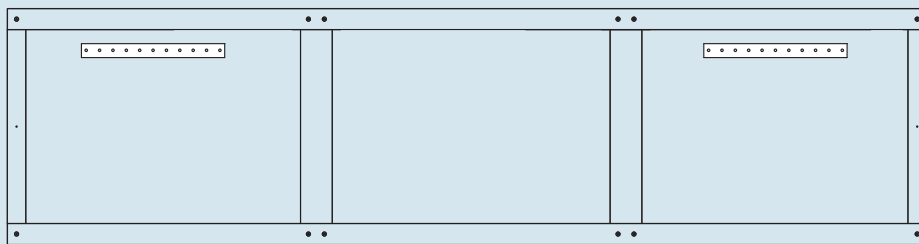
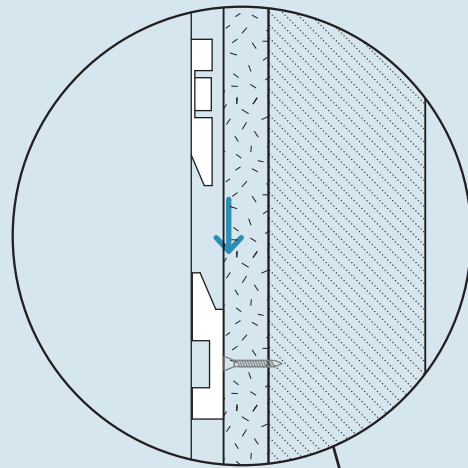

REAR VIEW

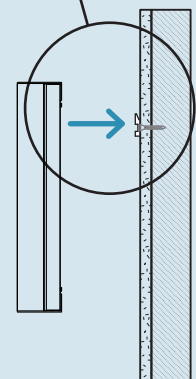

SIDE VIEW

Step 04

ATTACH ANTI-TIP BRACKET TO THE WALL.

If leaning Mirror Mirror against a wall an anti-tip kit is required. Install anti-tip bracket to wall stud 1" below mirror height.

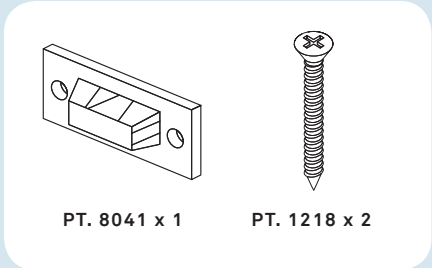
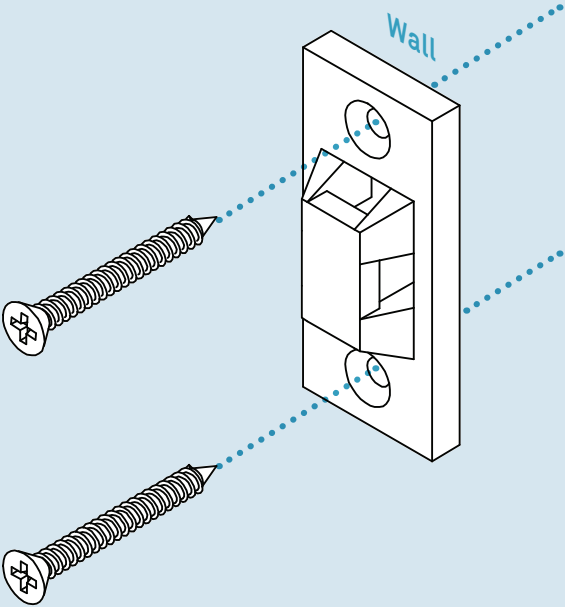

Step 05

INSTALL ANTI-TIP BRACKET TO MIRROR.

Bracket must be installed to wood rail. In order to prevent damage, it is recommended that 3/32" pilot holes be drilled prior to installation.

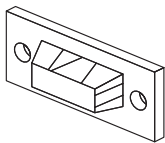
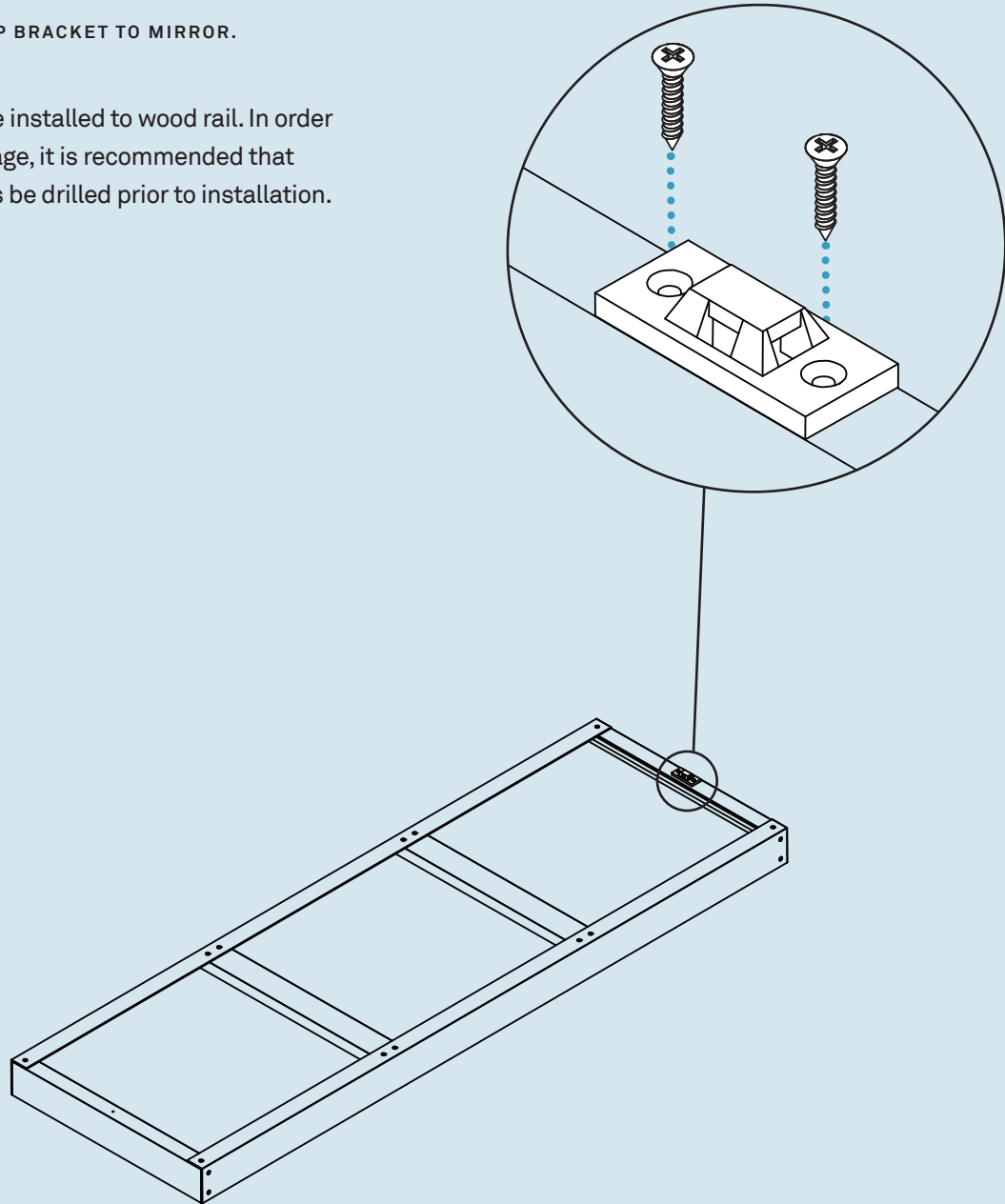

PT. 8041 x 1

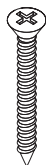

PT. 1218 x 2

Step 06

SECURE THE MIRROR.

Install and tighten the strap prior to using the product.

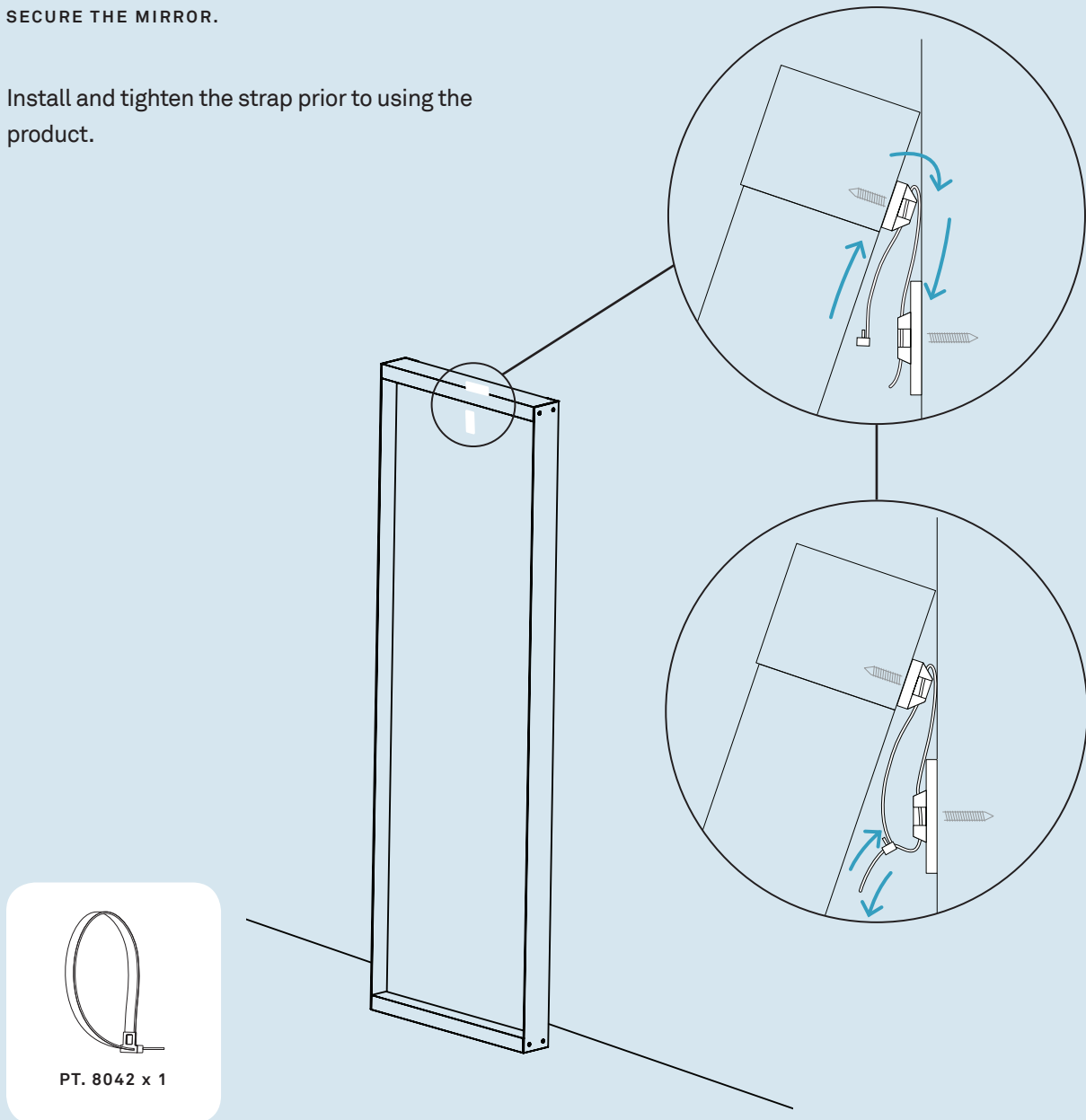

Additional Information

CLEAN

Clean with a slightly damp, soft cloth. To remove dirt and fingerprints, use a quality cleaner formulate for wood furniture. Wipe completely dry with a soft cloth in the direction of the wood grain.

