

# Flask Floor Lamp

DESIGNED IN 2016

ASSEMBLY NOTES | REV 01

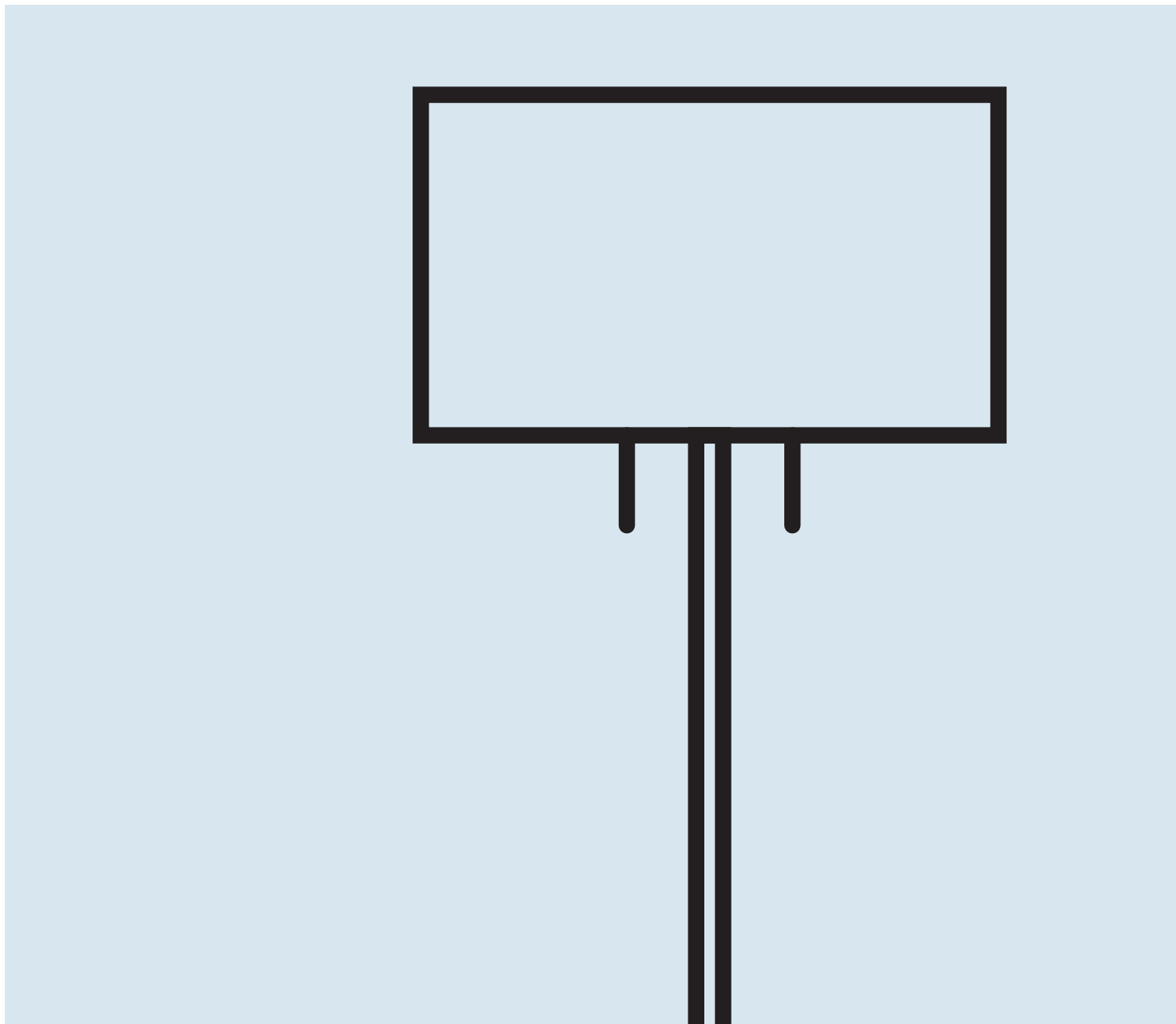
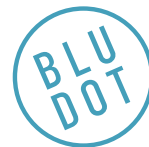

GOOD CHEMISTRY.

Class up any dark corner of your home with Flask.

NEED A HAND?

Contact us at [service@bludot.com](mailto:service@bludot.com) or  
**844.425.8368** for assistance.

# Parts & Hardware

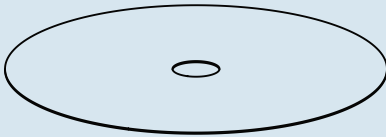

QTY

1

QTY

1

Diffuser

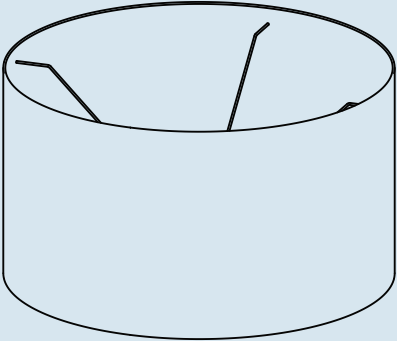

Shade

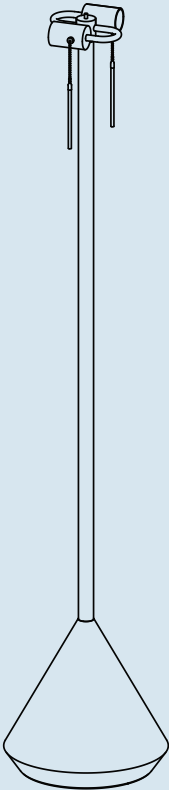

QTY

1

Base

Due to regulatory requirements light bulbs (E-26 23W CFL) are provided.  
We recommend using 100W maximum incandescent bulbs or LED, CFL equivalents.

## Step 01

### REMOVE SHADE FINIAL.

Unscrew shade finial from the base as shown.  
Take care not to lose finial.

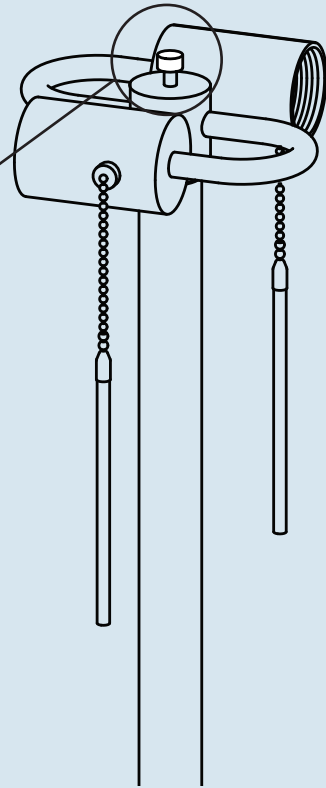
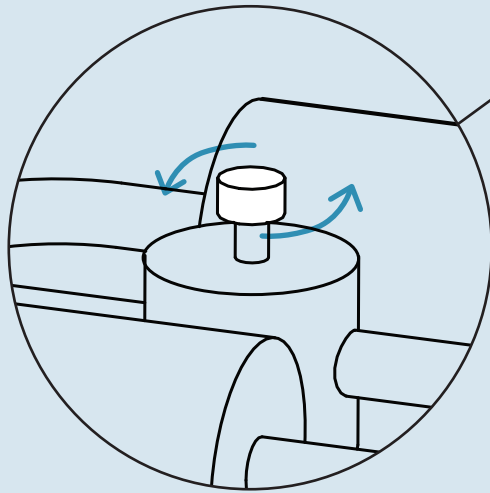

## Step 02

### ATTACH SHADE.

Place shade on base as shown. Secure in place  
with shade finial from Step 01.

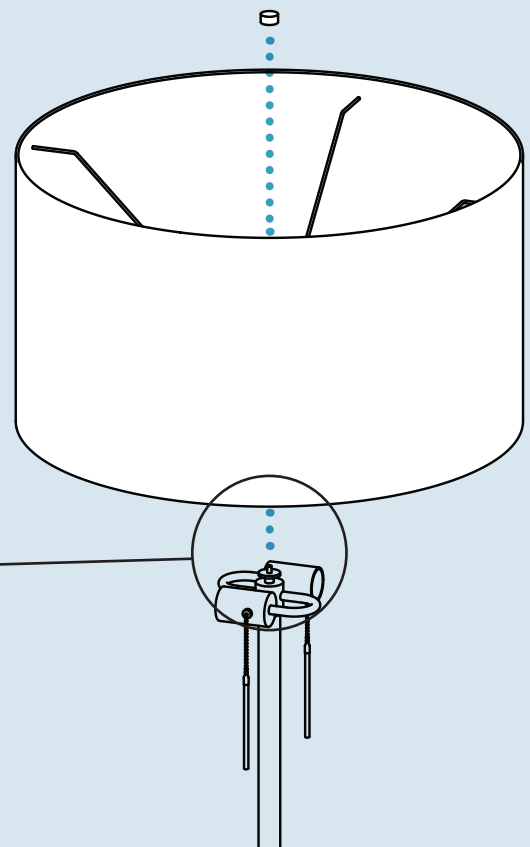
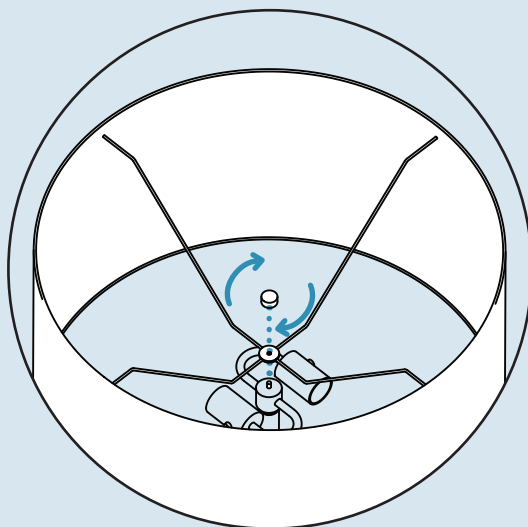

## Step 03

### INSTALL DIFFUSER.

Install diffuser as shown.

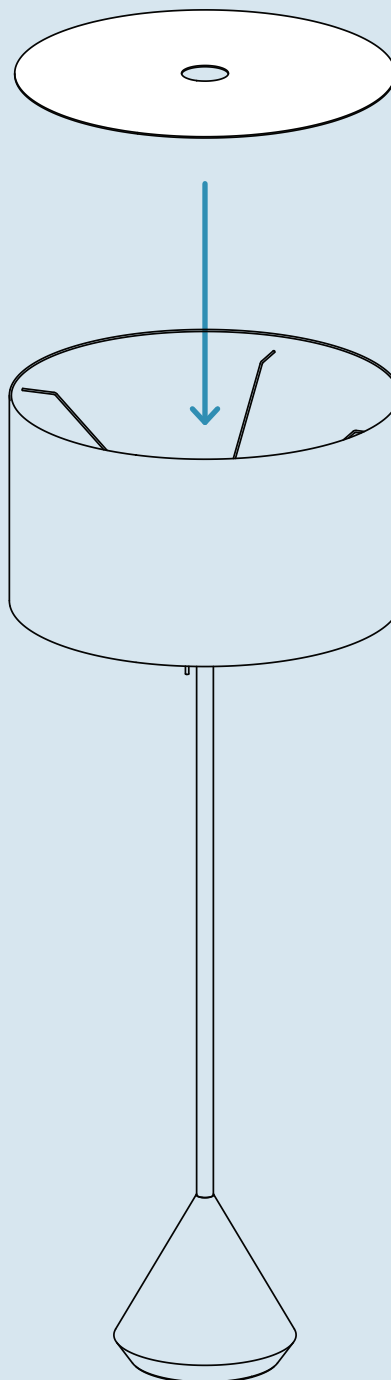

## Additional Information

### CLEAN

Unplug lamp prior to cleaning. Clean with a slightly damp, soft cloth. To remove dirt and fingerprints, use a quality cleaner formulate for wood furniture. Wipe completely dry with a soft cloth in the direction of the wood grain.

