

BLU
DOT

DANDY

ASSEMBLY INSTRUCTIONS

WELL THAT'S
JUST DANDY!

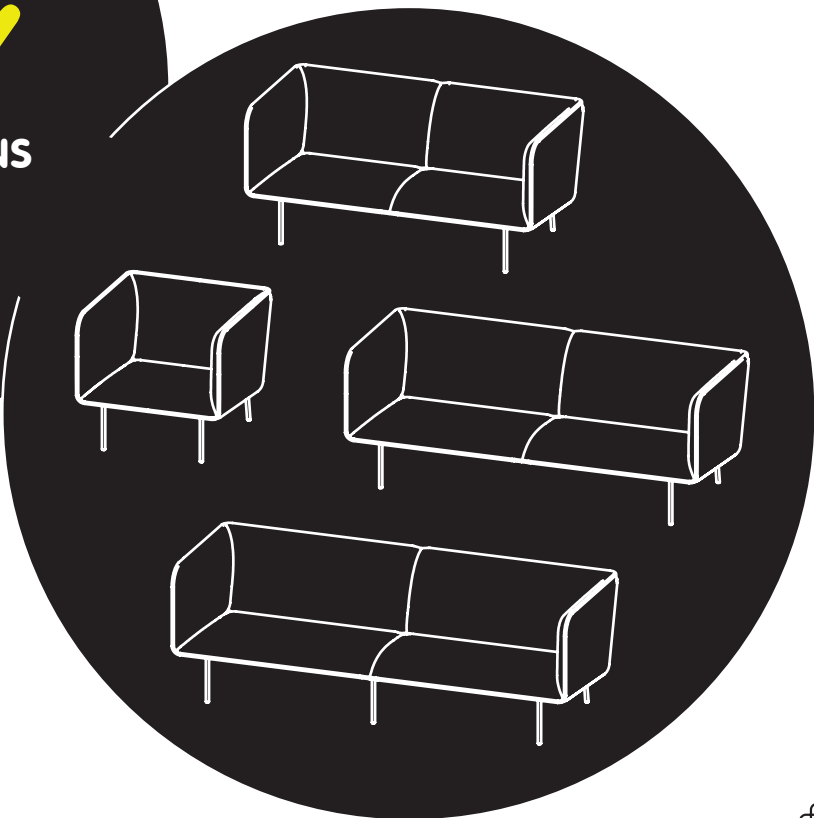

1

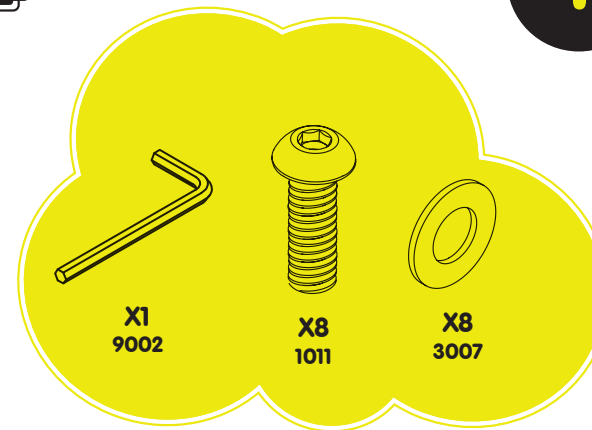

*
96" Sofa ships with
additional leg and
connection hardware.

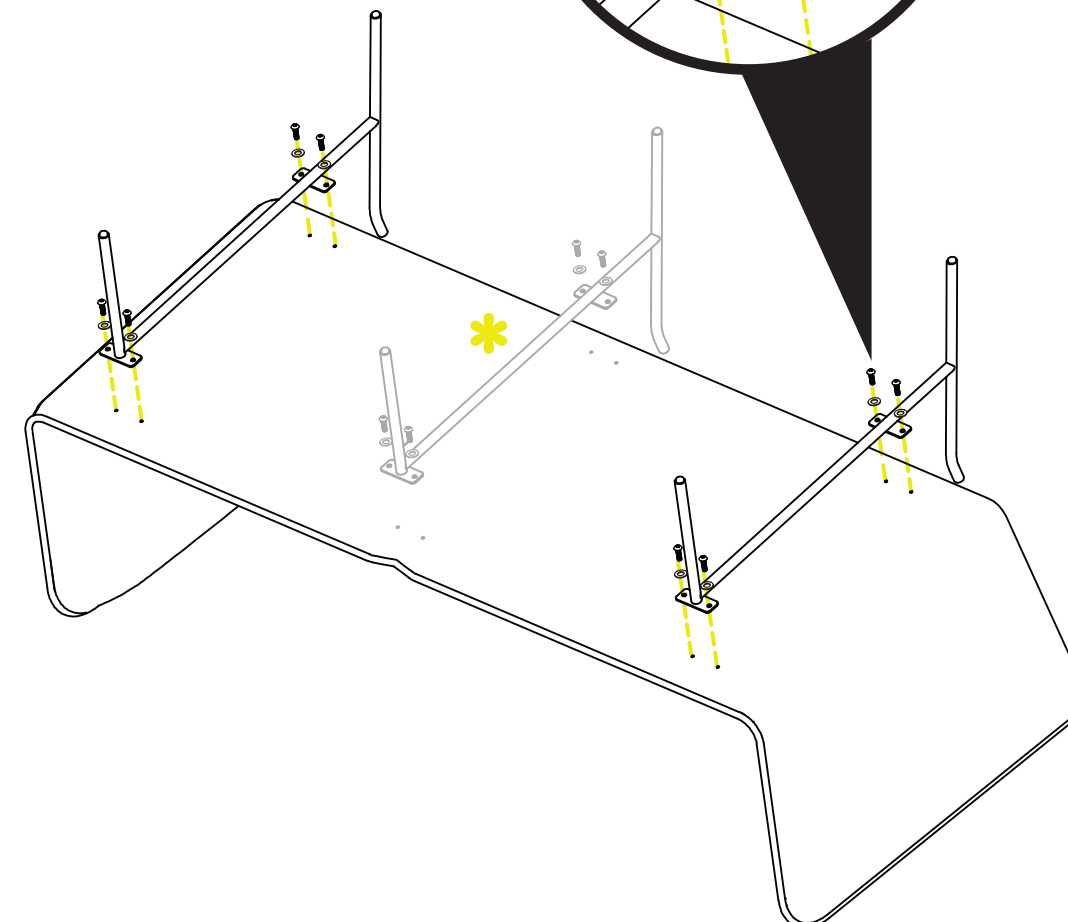
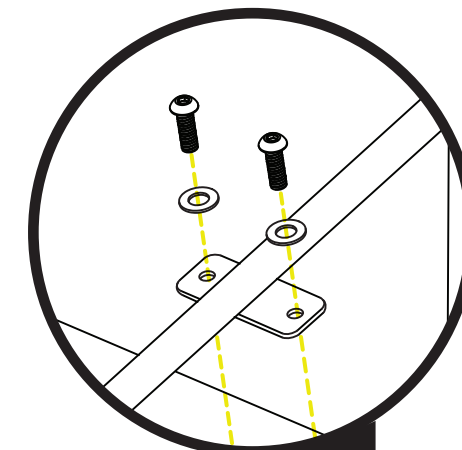

PARTS & HARDWARE

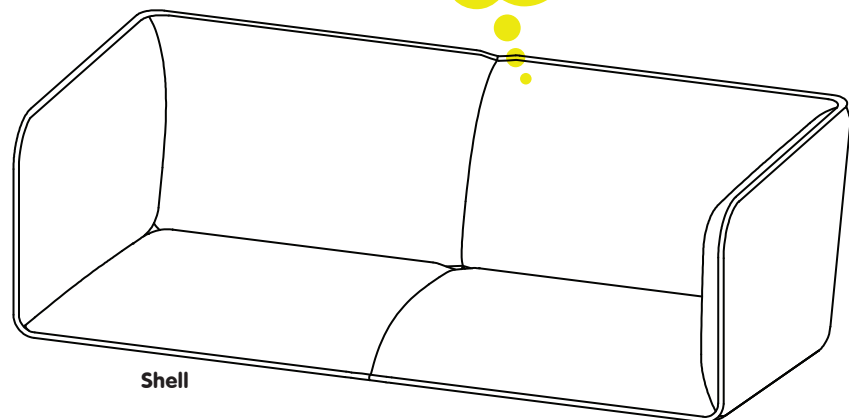

Shell

x1



x1
9002



x8
3007

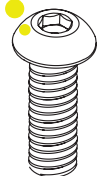

x8
1011

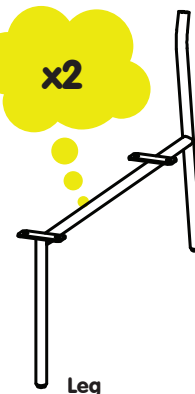

x2

Leg

96" SOFA SHIPS WITH ADDITIONAL HARDWARE



x4
3007

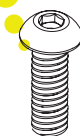

x4
1011

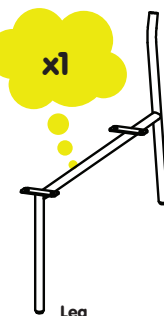

x1

Leg

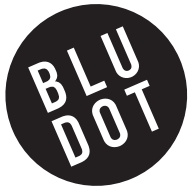

UPHOLSTERY CARE

KEEP IT CLEAN, JIMMY!

CARE

Vacuum your upholstery regularly to help retain its original look.

SPILLS

Act quickly with spills. Absorb the spill with a clean white cloth or paper towel. Never rub the surface. Spot clean with dry cleaning fluid. Do not use water or other liquids to clean, as they may stain the fabric. Consult a commercial cleaning specialist for removal of stubborn stains.

AVOID

Keep upholstery furniture out of direct sunlight and away from heat sources; excessive exposure to sunlight will fade the color of the upholstery. Avoid placing heavy or sharp objects on the furniture surface for long periods of time; this can cause permanent indentations in the fabric. For snags in the fabric, tuck loose threads into fabric or carefully push to reverse side. Never pull out or cut off loose threads.