

Chip Dining Chair

DESIGNED IN 2013

ASSEMBLY NOTES | REV KD01

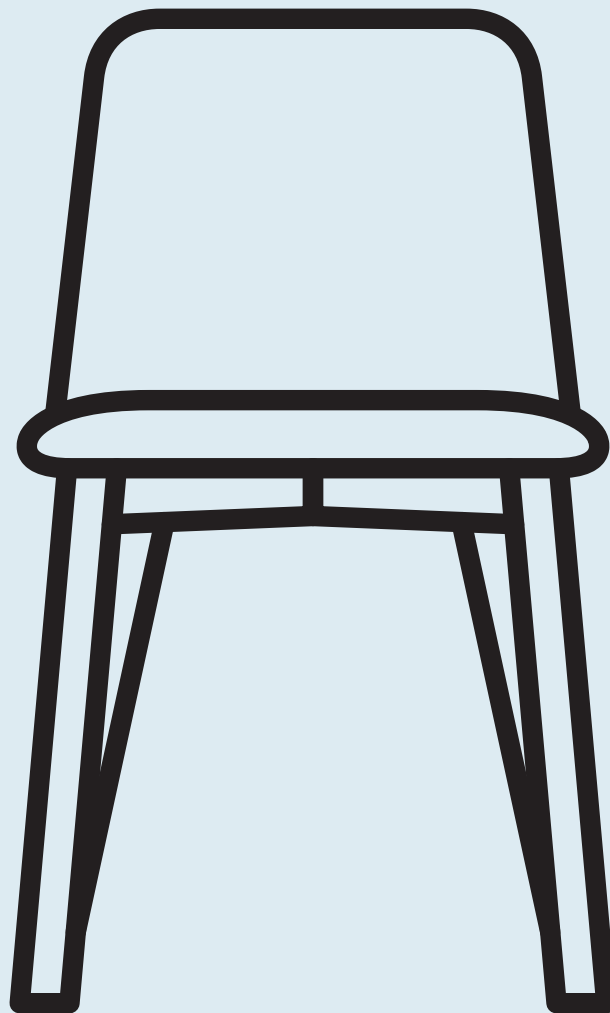
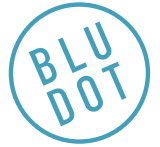

NEED A HAND?

Contact us at service@bludot.com or
844.425.8368 for assistance.

@BLUDOT

We design all our pieces in our Minneapolis studio. Follow
along on Instagram for some sneak peeks into the process.

Parts & Hardware

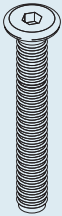

QTY 8

Pt. 1703

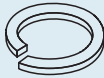

QTY 8

Pt. 3003

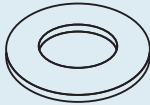

QTY 8

Pt. 3015



QTY 1

Pt. 9002

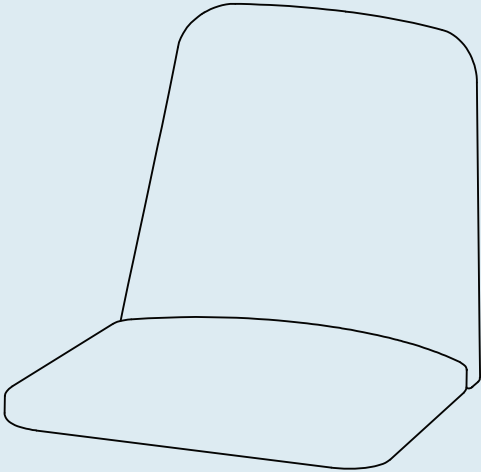

QTY 1

Seat

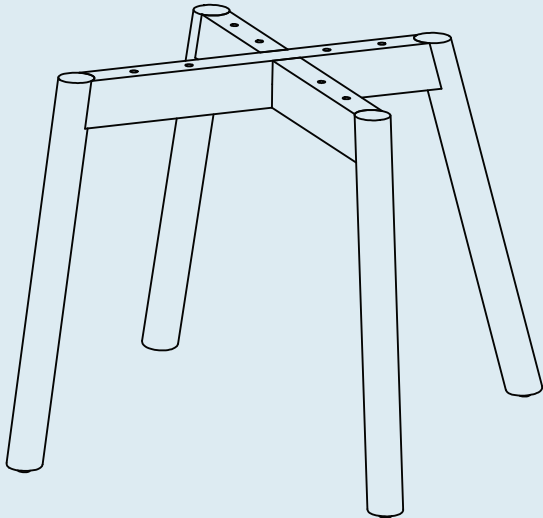

QTY 1

Base

Step 01

ATTACH SEAT TO BASE.

Attach the seat to the base as shown using the provided hardware.

Periodically tighten as needed to ensure the connection remains strong over time.

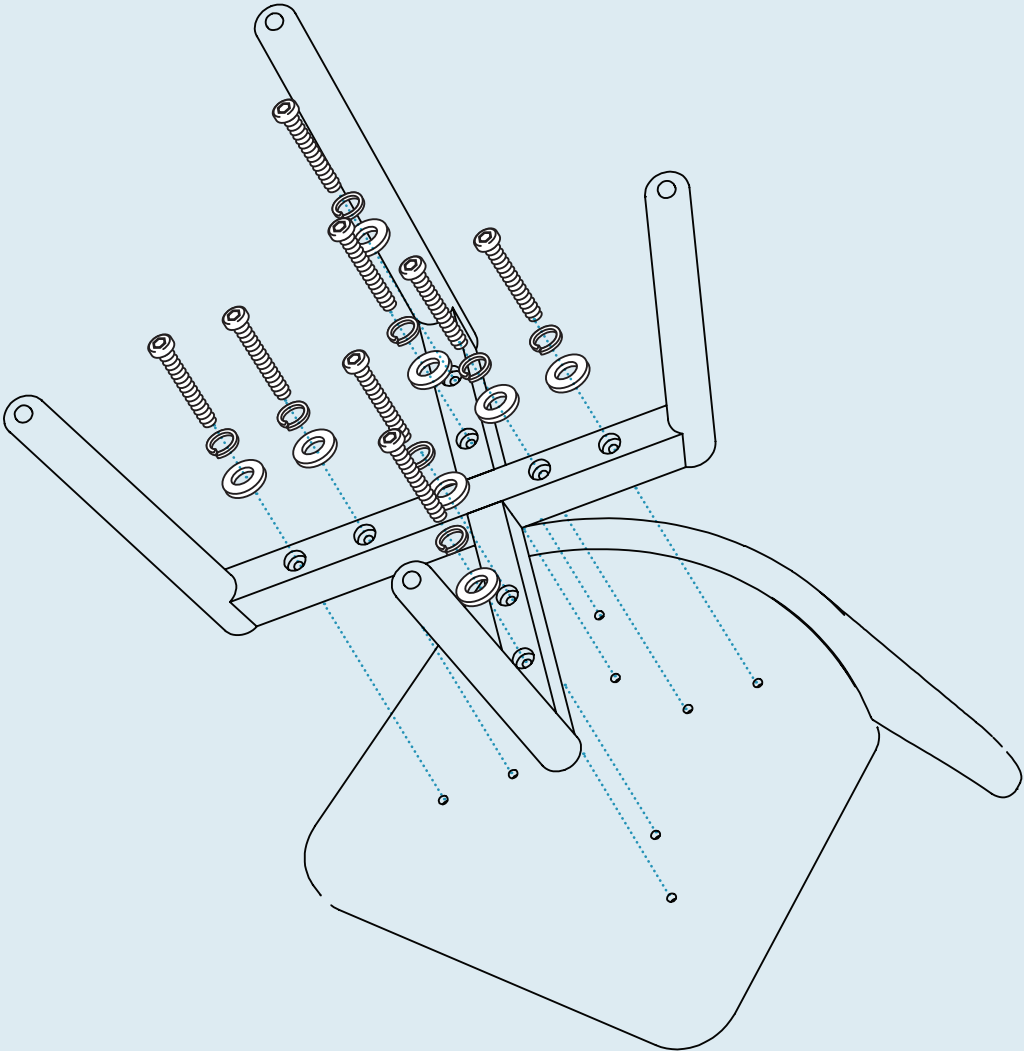

Pt. 1703 x 8



Pt. 3003 x 8



Pt. 3015 x 8



Pt. 9002 x 1

Additional Information

CLEAN

Vacuum your upholstery regularly. For leather furniture dust regularly with a dry cloth.

SPILLS

Act quickly with spills. Absorb the spill with a clean white cloth or paper towel. Never rub the surface. Do not use water or other liquids to clean, as they may cause stains. Consult a commercial cleaning specialist for removal of stubborn stains.

AVOID

Keep furniture out of direct sunlight and away from heat sources; excessive exposure to sunlight may cause color fading. Avoid placing heavy or sharp objects on the furniture surface for long periods of time; this can cause permanent surface indentations. For snags in the fabric, tuck loose threads into fabric or carefully push to reverse side. Never pull out or cut off loose threads.

