

# Bloke Sofa

DESIGNED IN 2017

ASSEMBLY NOTES | REV 00

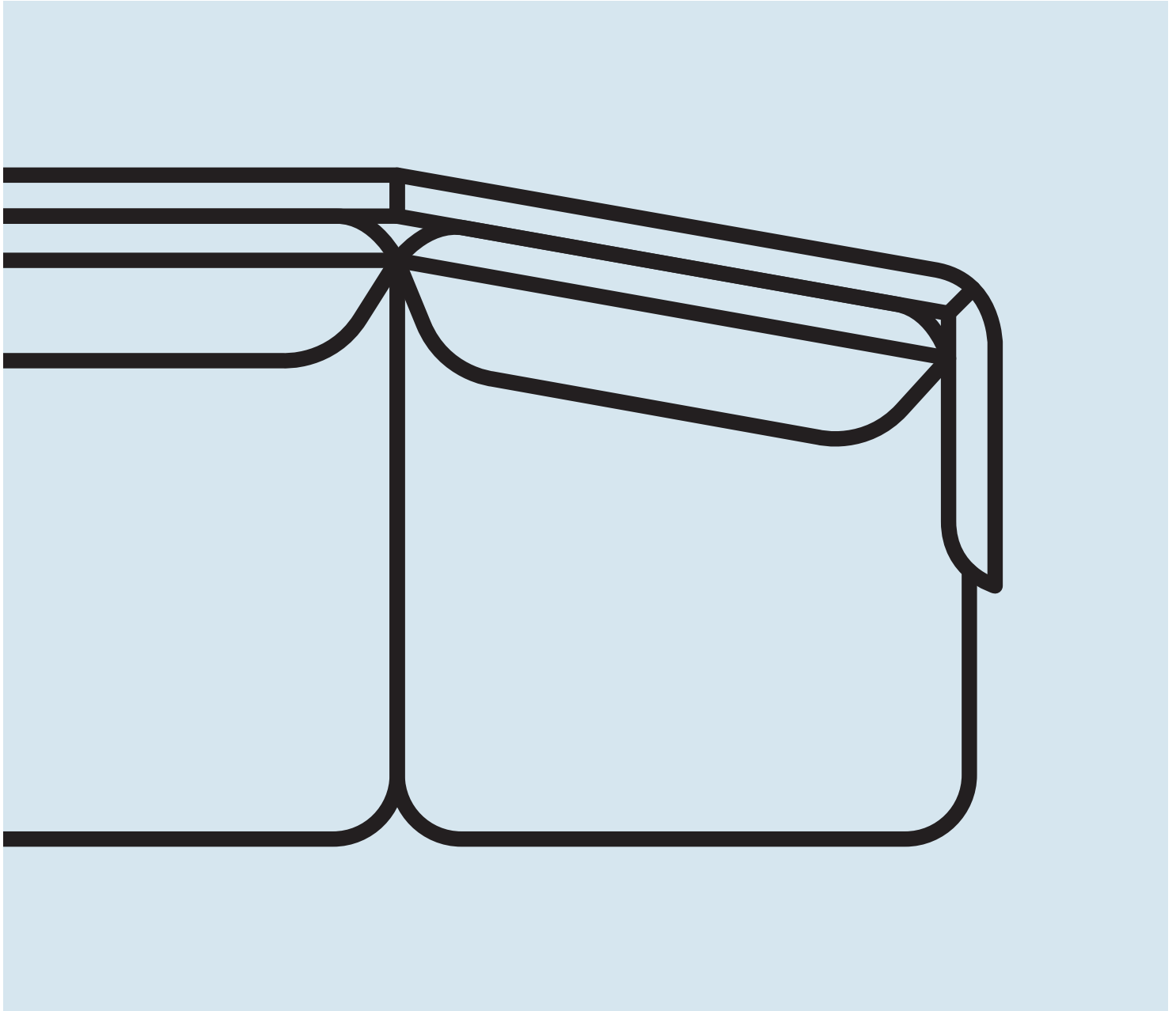
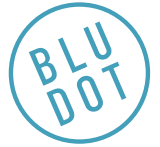

## YOU FANCY.

Bloke is equal parts refined haven and sofa. Fit for the Queen or keggers, Bloke is a sophisticate that knows how to have a lot of fun.

## NEED A HAND?

Contact us at [service@bludot.com](mailto:service@bludot.com) or **844.425.8368** for assistance.

# Parts & Hardware

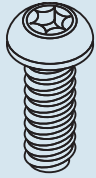

QTY

24\*

Pt. 1011

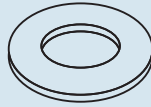

QTY

24\*

Pt. 3009

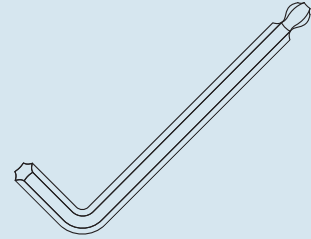

QTY

1

Pt. 9024



QTY

8\*

Leg

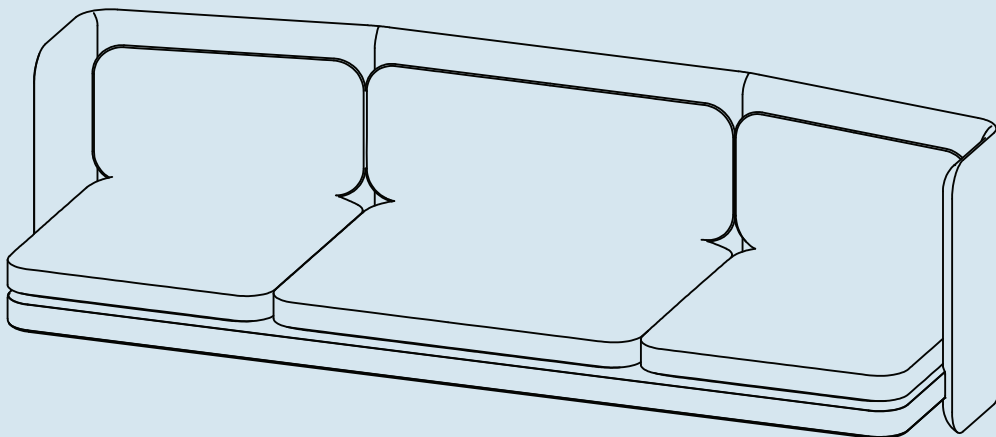

QTY

1

Sofa

\*small sofa ships with x6 legs.

# Step 01

## INSTALL LEGS.

Install legs as shown using the provided hardware.

After the legs have been attached, have a second person help lift and bring the frame upright in order to prevent leg damage.

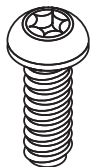
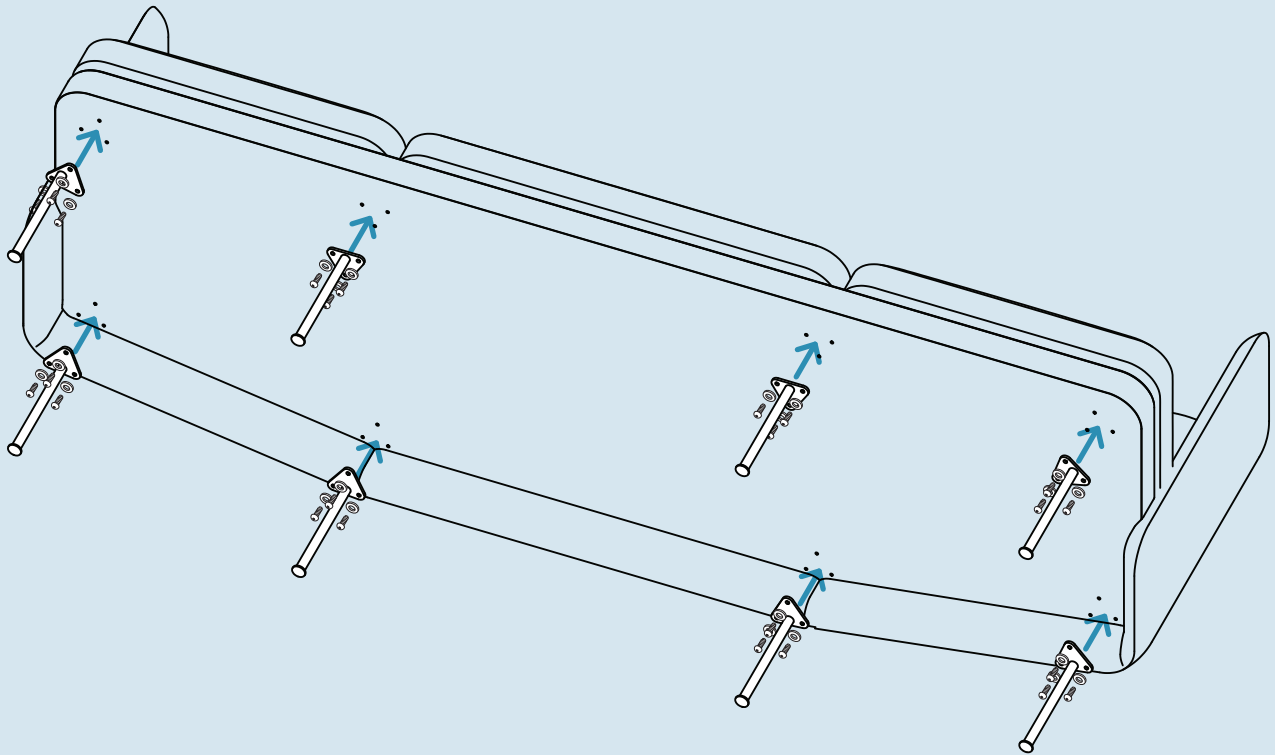

PT. 1011 x 24

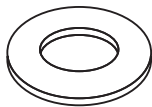

PT. 3009 x 24

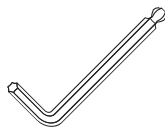

PT. 9024 x 1

## Additional Information

### CLEAN

Vacuum your upholstery regularly.

### SPILLS

Act quickly with spills. Absorb the spill with a clean white cloth or paper towel. Never rub the surface. Do not use water or other liquids to clean, as they may stain the fabric. Consult a commercial cleaning specialist for removal of stubborn stains.

### AVOID

Keep upholstery out of direct sunlight and away from heat sources; excessive exposure to sunlight may fade the color of the upholstery. Avoid placing heavy or sharp objects on the furniture surface for long periods of time; this can cause permanent indentations in the fabric. For snags in the fabric, tuck loose threads into fabric or carefully push to reverse side. Never pull out or cut off loose threads.

