

Bloke Sectional

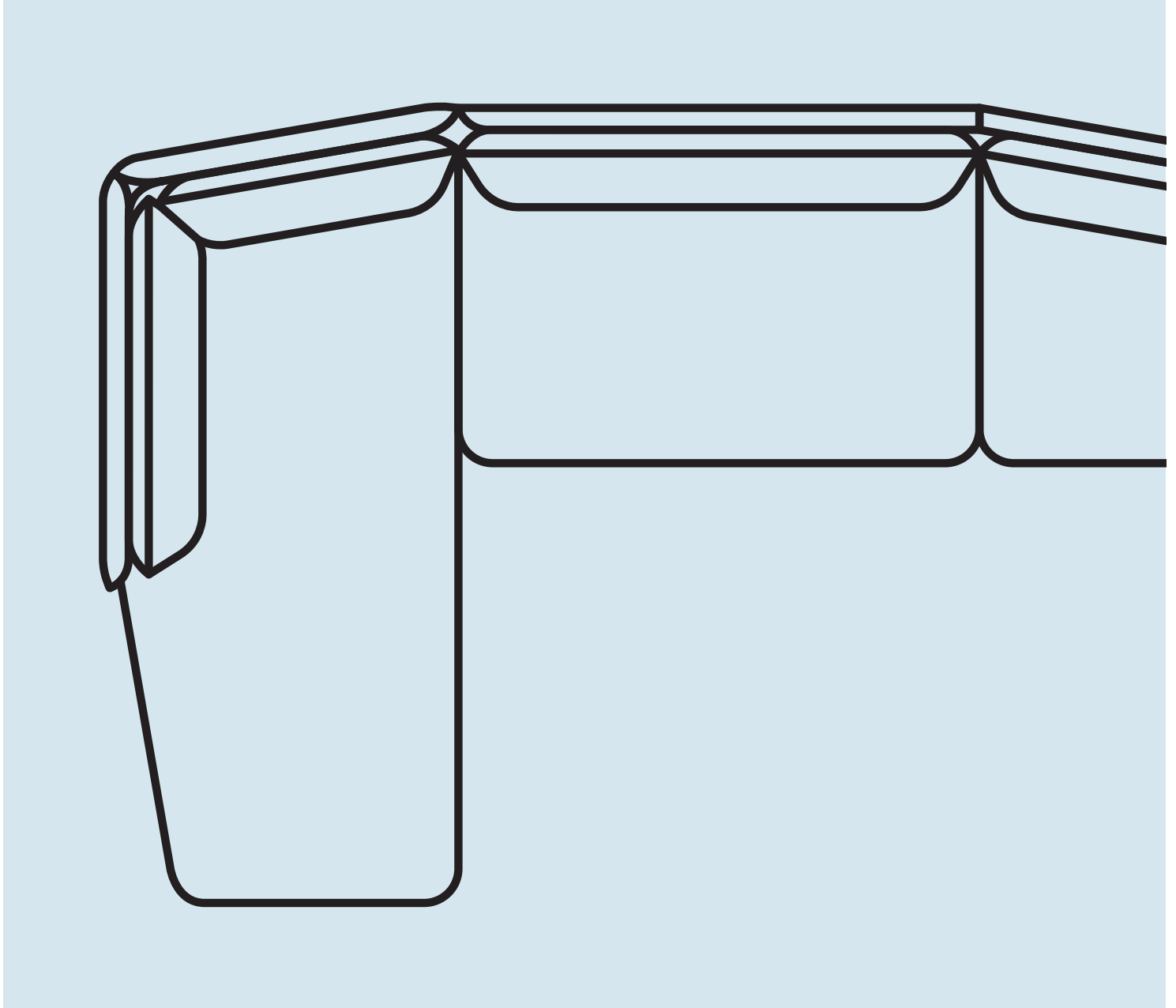

DESIGNED IN 2017

ASSEMBLY NOTES | REV 00



YOU FANCY.

Bloke is equal parts refined haven and sofa. Fit for the Queen or keggers, Bloke is a sophisticate that knows how to have a lot of fun.

NEED A HAND?

Contact us at service@bludot.com or **844.425.8368** for assistance.

Parts & Hardware

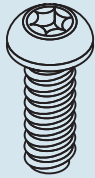

QTY 12

Pt. 1011

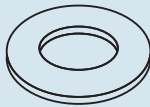

QTY 12

Pt. 3009

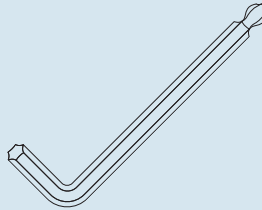

QTY 1

Pt. 9024



QTY 6

Pt. 1216

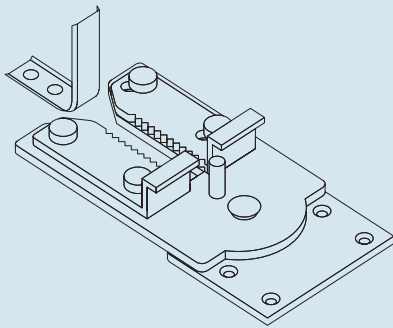

QTY 1

Pt.8034



QTY 4

Leg

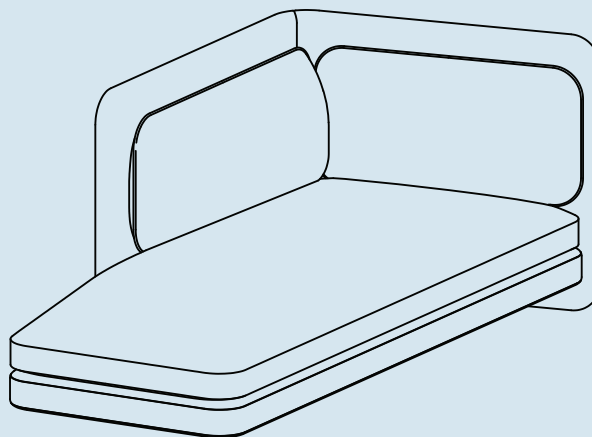

QTY 1

Sectional

Step 01

INSTALL LEGS.

Install legs as shown using the provided hardware.

After the legs have been attached, have a second person help lift and bring the frame upright in order to prevent leg damage.

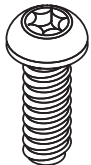
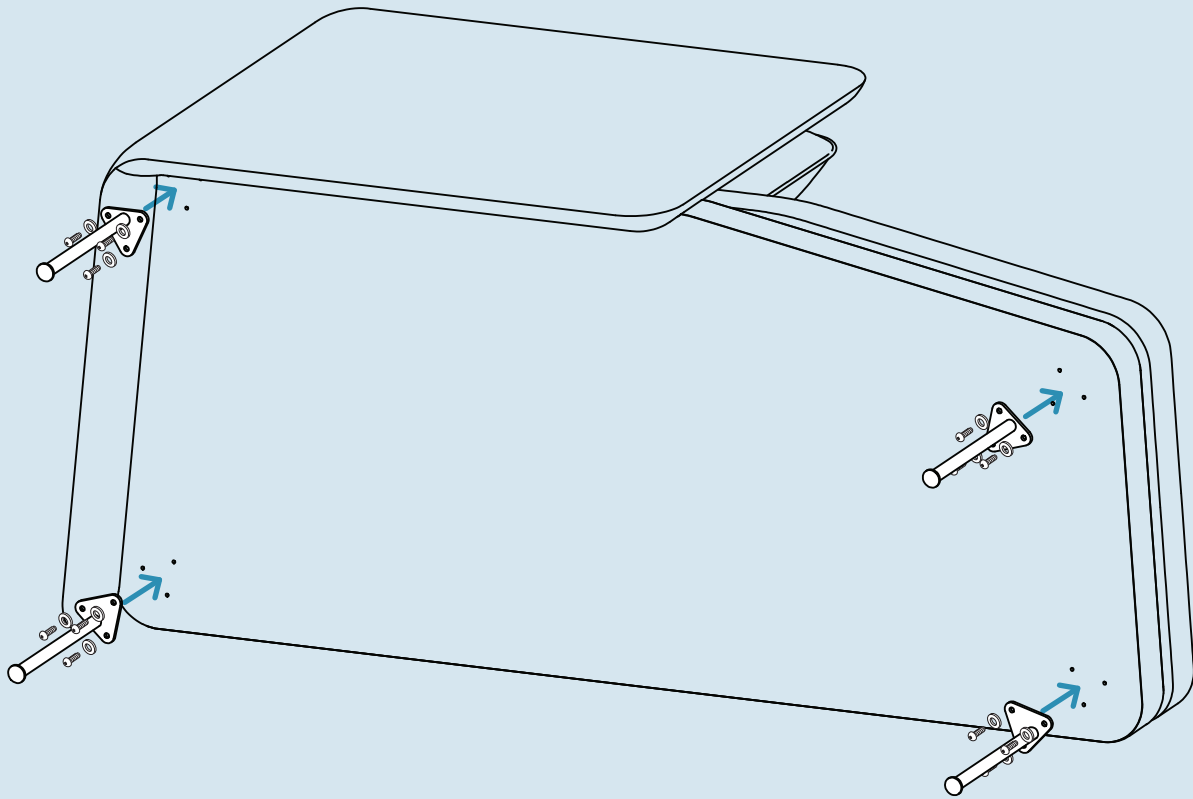

PT. 1011 x 12

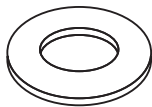

PT. 3009 x 12

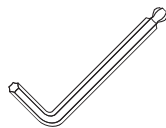

PT. 9024 x 1

Step 02

ATTACH MALE SECTIONAL CONNECTOR.

This hardware allows proper alignment of the sectional sofas and holds them in place during use.

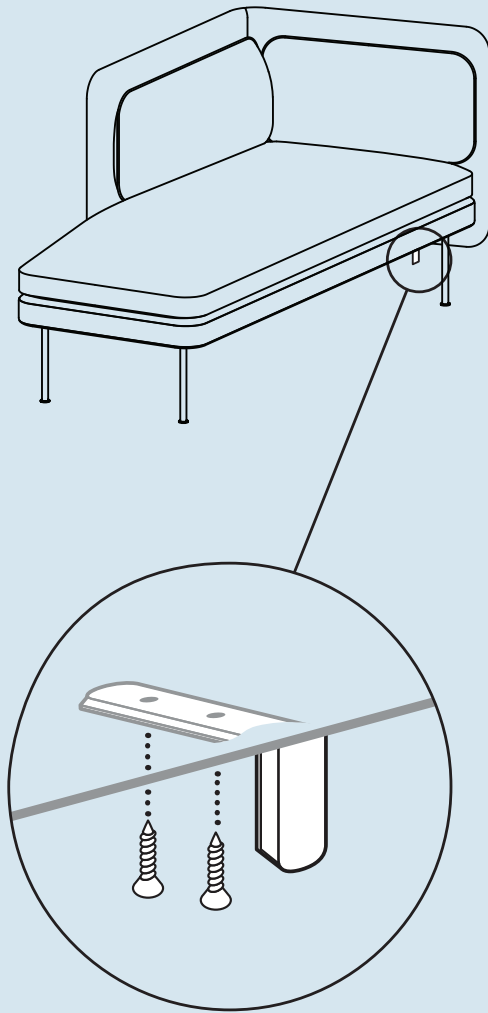

Underside of Chaise

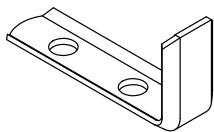
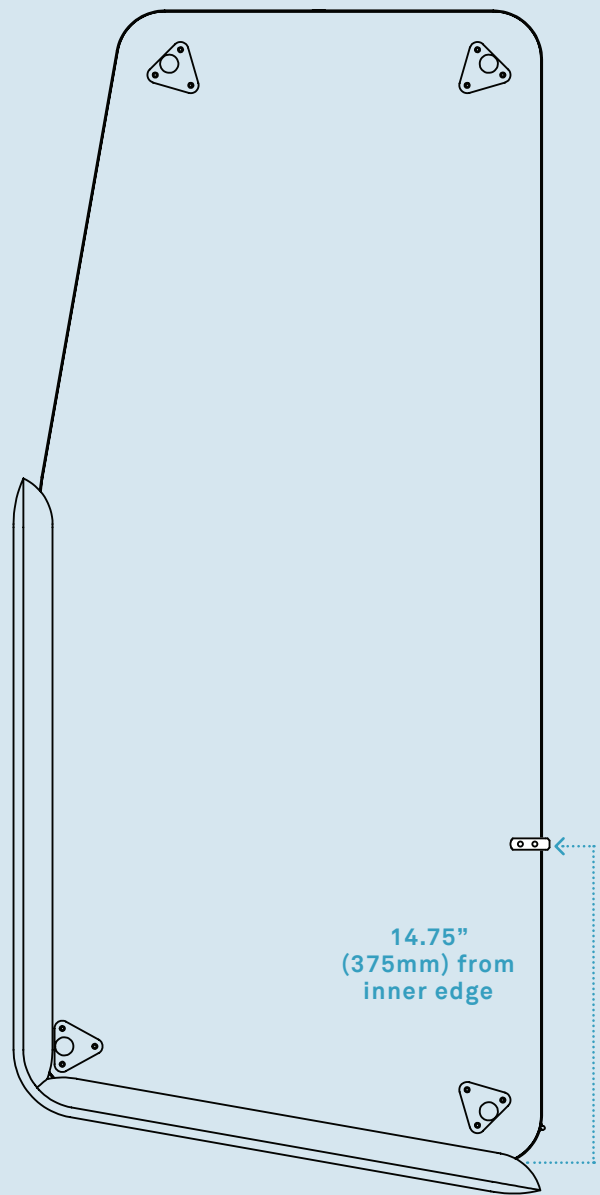

Pt. 8034 x 1

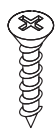

PT. 1216 x 2

Step 03

ATTACH FEMALE SECTIONAL CONNECTOR

This hardware allows proper alignment of the sectional sofas and holds them in place during use.

Underside of One Arm Sofa

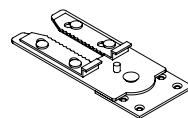
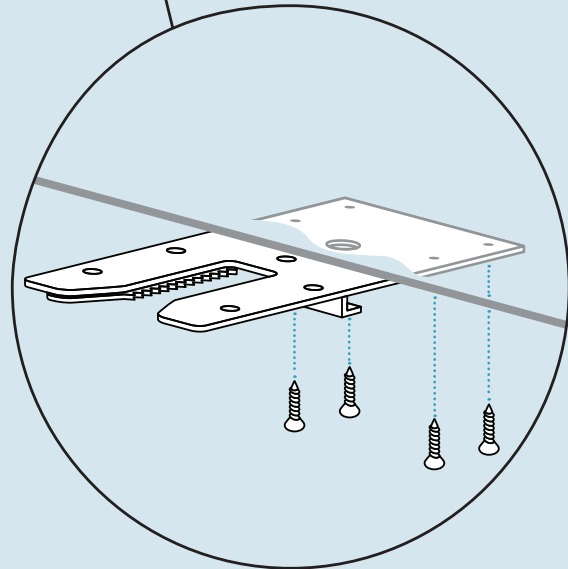
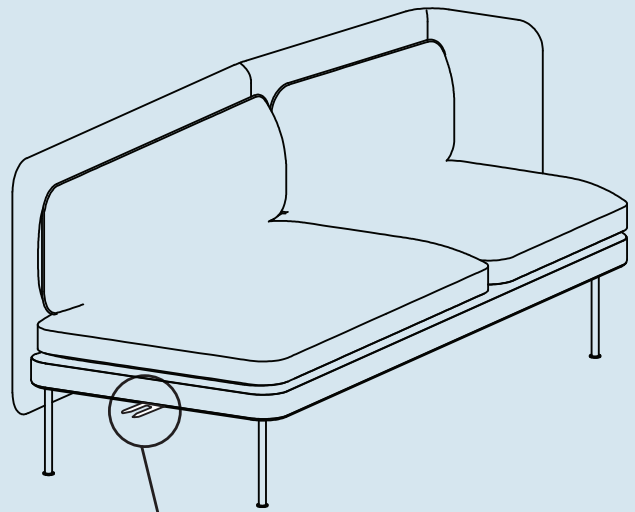
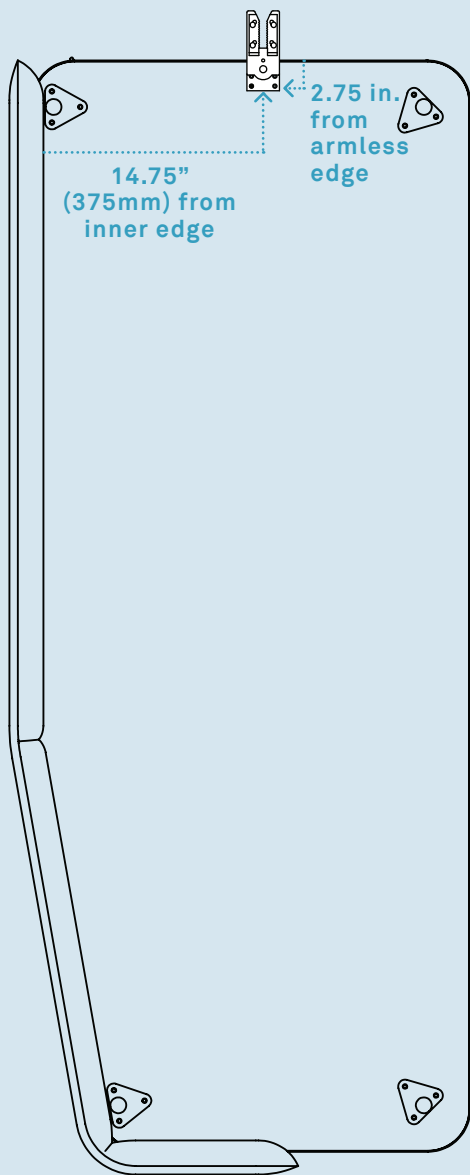

Pt. 8034 x 1



PT. 1216 x 4

Step 04

CONNECT SECTIONAL SOFAS.

With back sides aligned, carefully slide sectional sofas together.

Make sure sectional connector latches for a secure placement.

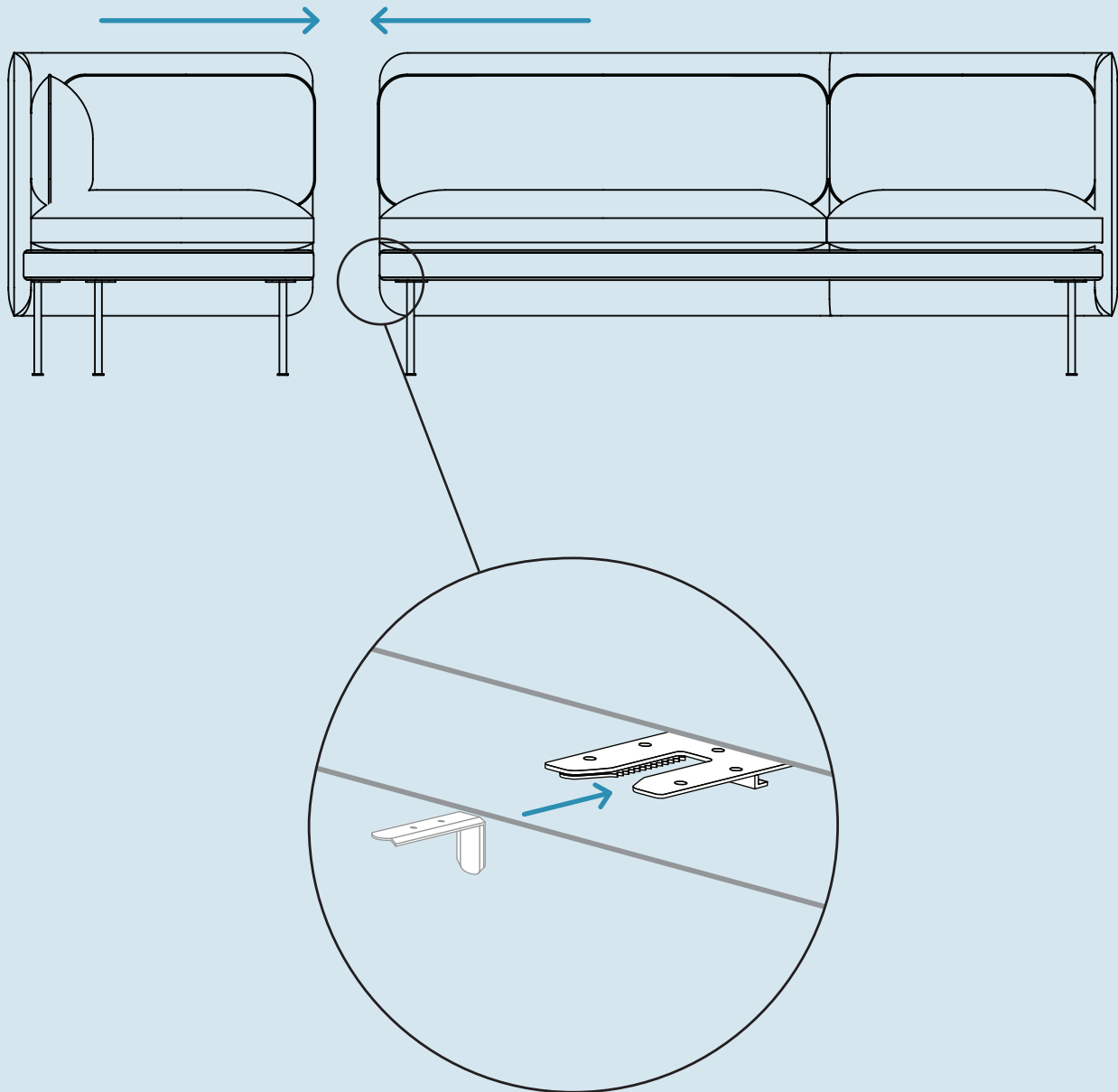

Additional Information

CLEAN

Vacuum your upholstery regularly.

SPILLS

Act quickly with spills. Absorb the spill with a clean white cloth or paper towel. Never rub the surface. Do not use water or other liquids to clean, as they may stain the fabric. Consult a commercial cleaning specialist for removal of stubborn stains.

AVOID

Keep upholstery of direct sunlight and away from heat sources; excessive exposure to sunlight may fade the color of the upholstery. Avoid placing heavy or sharp objects on the furniture surface for long periods of time; this can cause permanent indentations in the fabric. For snags in the fabric, tuck loose threads into fabric or carefully push to reverse side. Never pull out or cut off loose threads.

