

A Walk in the Park Dining Table

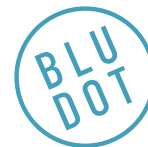

DESIGNED IN 2016

ASSEMBLY NOTES | REV 06

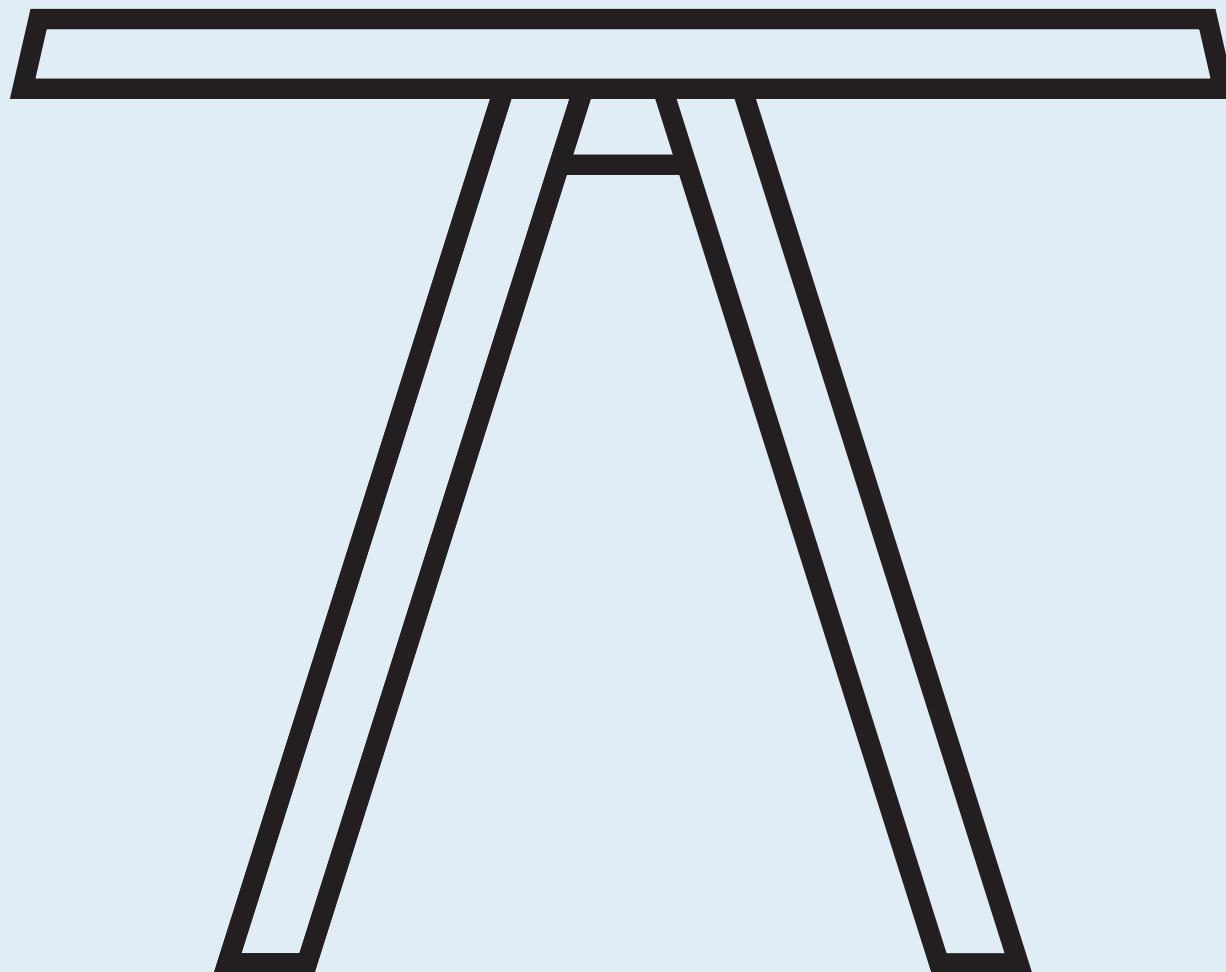

MAJOR.

Balancing mass with proportion, the beveled edge of the table adds gentility to the thick wood top and the beefy legs stay tucked out of the way of chairs to make the most of the dining surface. Elbows totally allowed.

NEED A HAND?

Contact us at service@bludot.com or **844.425.8368** for assistance.

Parts & Hardware

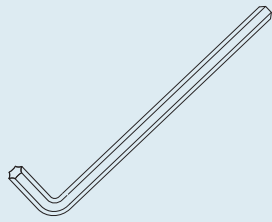

QTY 1

Pt. 9022

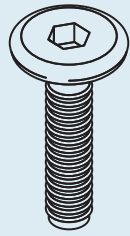

QTY 18

Pt. 1603

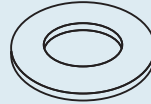

QTY 18

Pt. 3002



QTY 2

Pt. 8044

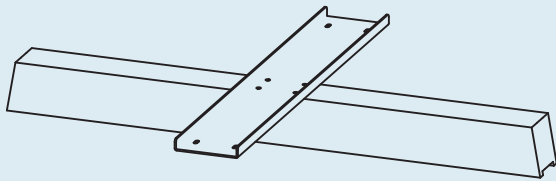

QTY 1

Center Beam

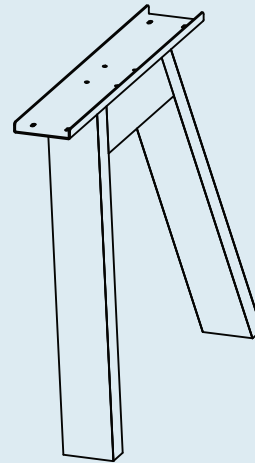

QTY 2

Leg

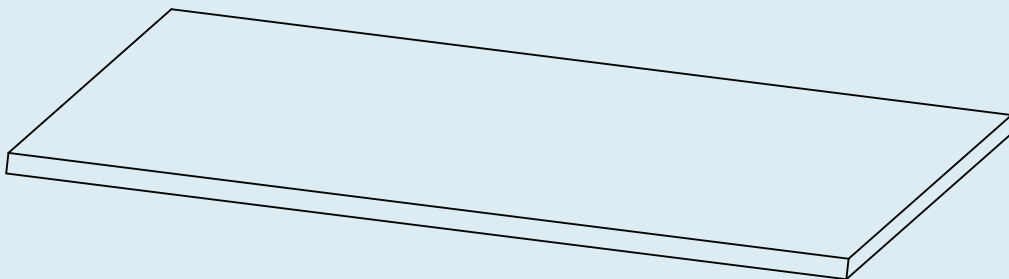

QTY 1

Top

Step 01

ATTACH LEGS.

Attach the legs as shown using the provided hardware.

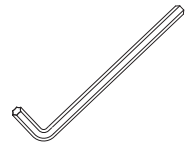
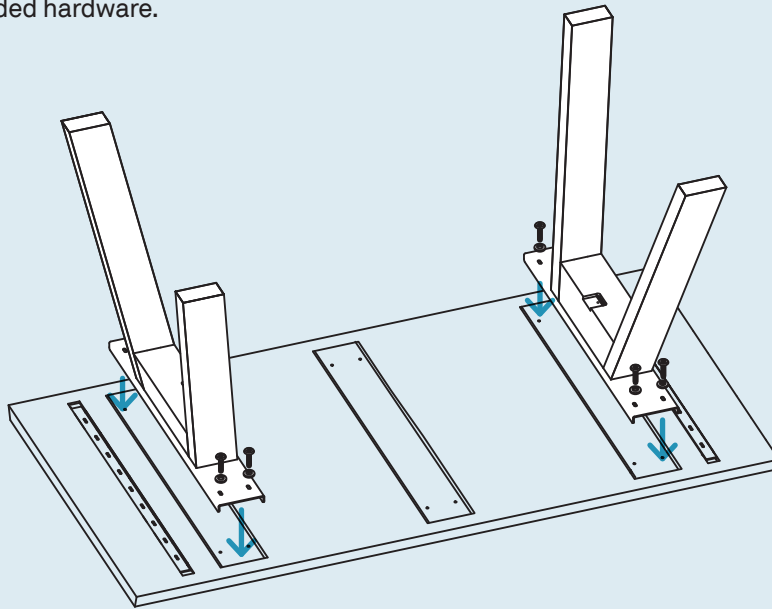

PT. 9022 X 1

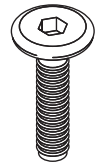

PT. 1603 X 8



PT. 3002 X 8

Step 02

ATTACH CENTER BEAM.

Attach the center beam as shown using the provided hardware.

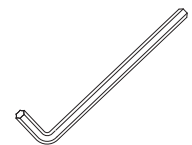
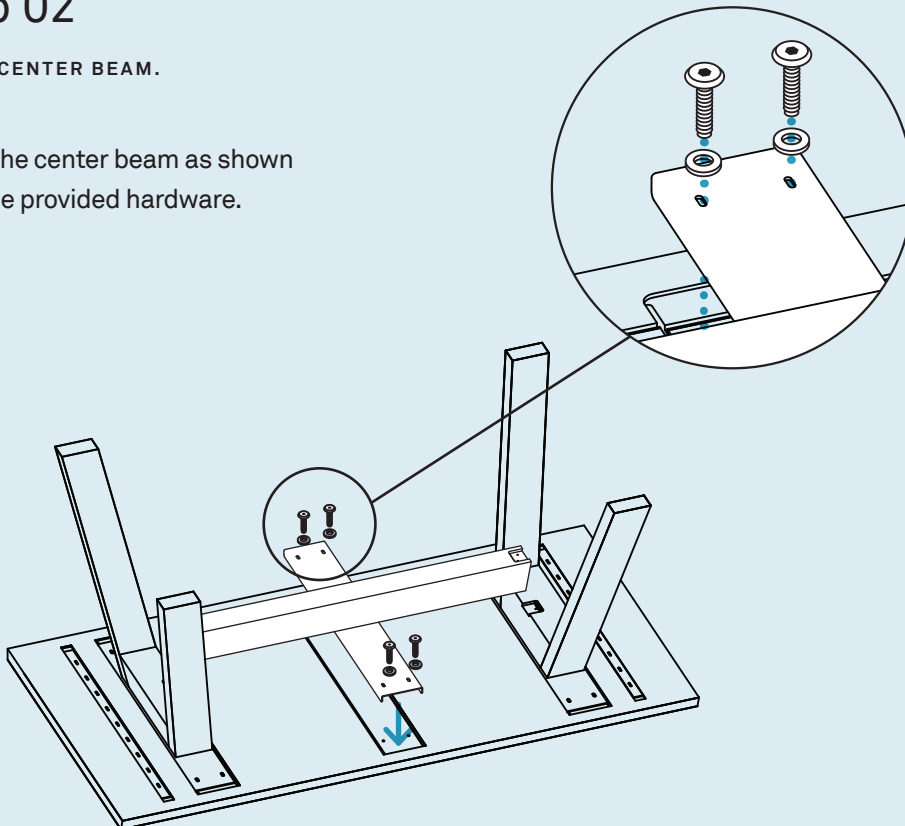

PT. 9022 X 1

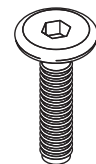

PT. 1603 X 4



PT. 3002 X 4

Step 03

INSTALL CONNECTOR PLATES.

Install the connector plates as shown using the provided hardware.

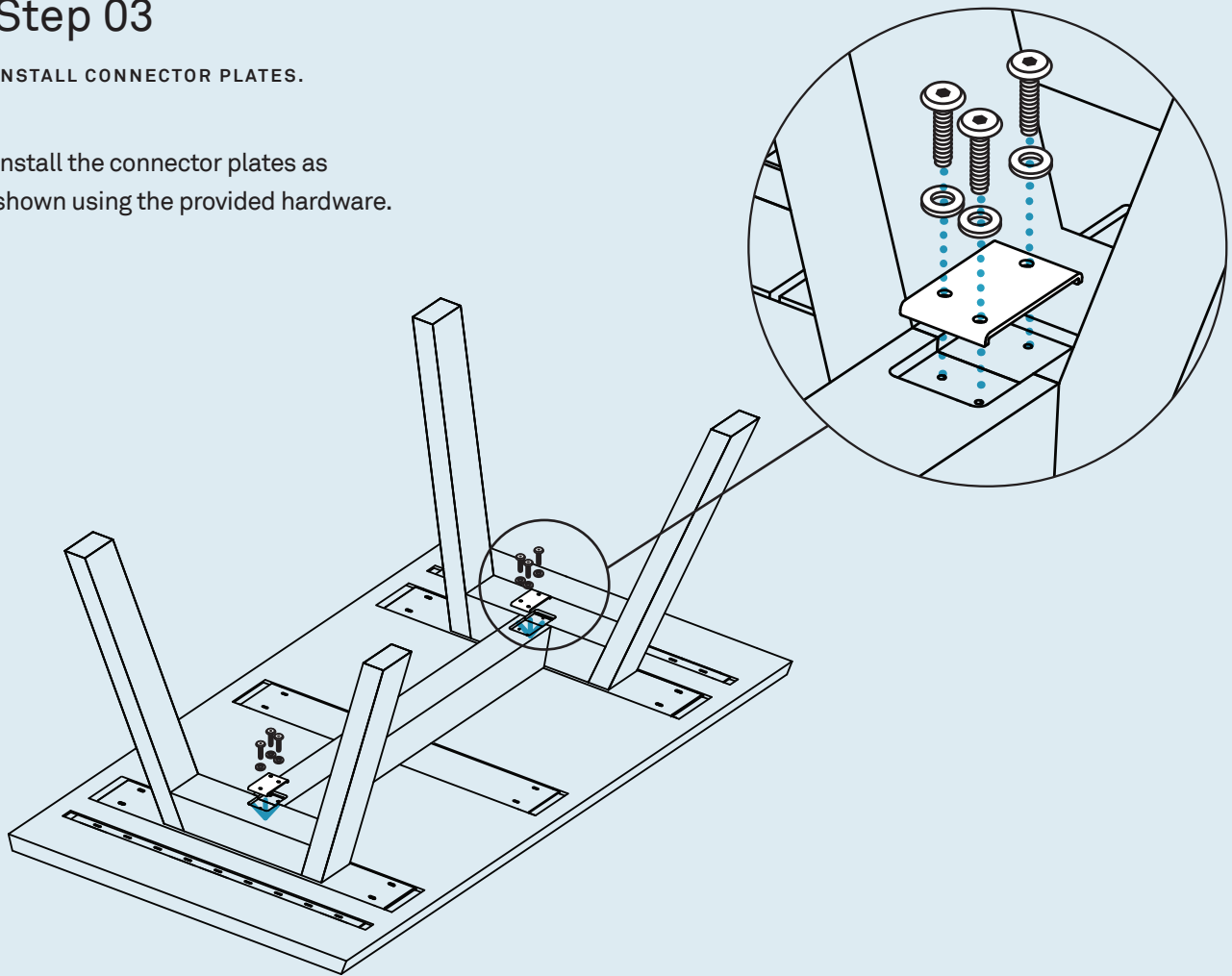

Pt. 8044 x 2

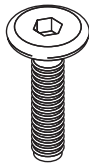

Pt. 1603 x 6

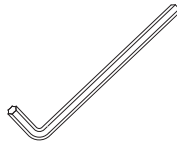

Pt. 9022 x 1



PT. 3002 X 6

Additional Information

CLEAN

Clean with a slightly damp, soft cloth. To remove dirt and fingerprints, use a quality cleaner formulate for wood furniture. Wipe completely dry with a soft cloth in the direction of the wood grain.

